



Circular Power Connectors

A full range of IP66, IP68 and IP69K rated environmentally sealed circular connectors designed to provide secure and safe connections in harsh or hostile conditions.

The Power Buccaneer range consist of the miniature 400, Mini, Standard, 900, 7000 and 6000 Series. Screw terminations ensure simple 'field' connection, while crimp terminations fulfil the requirement for fast effective volume connections.

Each range has flex cable connector, Inline cable connector and panel mounting connector options. Over molded versions of the 400 series and Standard Buccaneer provide safe, secure and tamperproof cable termination.

With a wide choice of alternatives from 2 to 32 Contacts, BNC connections and screw, solder or crimp terminations, the Buccaneer range provides the answer to many design problems.

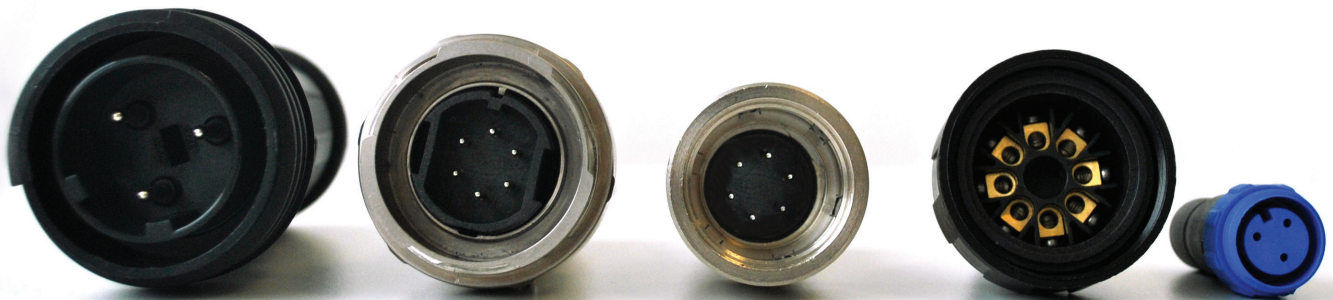

EXPlora	2
900 Series Buccaneer	8
Standard Buccaneer	14
Mini Buccaneer	24
400 Series Buccaneer	28
4000 Series Buccaneer	34
6000 Series Buccaneer	47
7000 Series Buccaneer	49
9000 Series High Power Buccaneer	57

The EXPlora range is most suited to manufacturers of ancillary electrical equipment such as motors, pumps, lighting equipment, process and control gear for use in factories and plant where hazardous or explosive atmospheres can be caused by flammable gases, mists or vapours or by combustible dusts.



Independently tested for compliance to ATEX standards for use in Zone 2 and Zone 22 environments, the new EXP series is manufactured from a tough, high grade UL94V-0 rated Polyester material and provides environmental sealing to IP68. The ATEX coding is: Ex II 3 GD and the certificated no: Baseefa09ATEX0232X.

EXPlora is rated up to 18A, 600V AC/DC for 2, 3, 4 and 5 Contacts, 16A, 430V AC/DC for 7 Contact and 10A, 250V AC/DC for 10 Contacts. The 3, 4, 5 and 7 Contact versions have leading earth contacts making them suitable for single or three phase applications.



- ⊞ ATEX approval for Zone 2 and Zone 22 applications
- ⊞ Independently tested
- ⊞ ATEX Coding:  Ex II 3 GD
- ⊞ ATEX Classification: Ex nA IIC T6 Gc
Ex tc IIIC T85°C Dc
- ⊞ ATEX Certificate No: Baseefa09ATEX0232X
- ⊞ IP68 rating tested at 1.054kg/sq cm (15lb/sq in)
- ⊞ 10m depth for 2 weeks
- ⊞ Up to 18A, 600V AC/DC rating
- ⊞ 2, 3, 4, 5, 7 and 10 Contact
- ⊞ Leading earth contact for 3, 4, 5 & 7 Contact versions
- ⊞ Trailing Neutral on 5 Contact
- ⊞ Plug or socket connection in each body style
- ⊞ Water and dustproof to IP68 when mated
- ⊞ 'Scoop proof' contacts
- ⊞ Field termination - screw terminations
- ⊞ Positive locating keyways - cannot be mis-connected
- ⊞ Sealing caps available to maintain IP68 rating of unmated connectors
- ⊞ Compact design
- ⊞ Easy assembly - no special tools required
- ⊞ Single or 3 phase applications
- ⊞ Cost effective solution
- ⊞ Cable acceptance from 7 to 22mm O/D
- ⊞ Two cable connector versions for 15mm and 22mm (maximum) cable diameters
- ⊞ Separate strain relief on large cable version

Flex Cable Connector



EXP-0911

- Mates with Inline or panel mounting versions
- Positive, fast acting locking ring - can be turned with a gloved hand
- Plug or socket versions
- EXP-0 Series 13-15mm cable dia. acceptance as standard, 7-13mm with additional Gland Pack PX0980

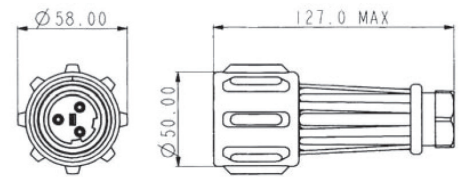

Flex Cable Connector



EXP-A911

- EXP-A Series 20-22mm cable dia. Acceptance as standard, 14-20mm with additional Gland Pack PXA980
- Strain Relief Clamp

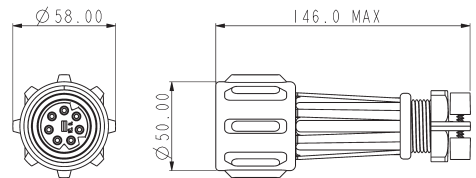

Standard Cable	Large Cable	Description	Standard Cable	Large Cable	Description
EXP-0911/02/P	EXP-A911/02/P	2 Contact Plug	EXP-0911/02/S	EXP-A911/02/S	2 Contact Socket
EXP-0911/03/P	EXP-A911/03/P	3 Contact Plug	EXP-0911/03/S	EXP-A911/03/S	3 Contact Socket
EXP-0911/04/P	EXP-A911/04/P	4 Contact Plug	EXP-0911/04/S	EXP-A911/04/S	4 Contact Socket
EXP-0911/05/P	EXP-A911/05/P	5 Contact Plug	EXP-0911/05/S	EXP-A911/05/S	5 Contact Socket
EXP-0911/07/P	EXP-A911/07/P	7 Contact Plug	EXP-0911/07/S	EXP-A911/07/S	7 Contact Socket
EXP-0911/10/P	EXP-A911/10/P	10 Contact Plug	EXP-0911/10/S	EXP-A911/10/S	10 Contact Socket

Inline Cable Connector



EXP-0921

- Mates with either EXP-0911 or EXP-A911 connectors
- Plug or socket versions
- EXP-0 Series 13-15mm cable dia. acceptance as standard, 7-13mm with additional Gland Pack PX0980

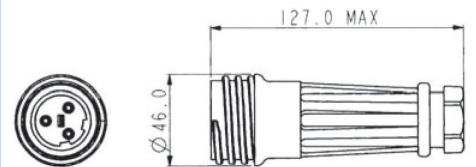

Inline Cable Connector



EXP-A921

- EXP-A Series 20-22mm cable dia. acceptance as standard, 14-20mm with additional Gland Pack PXA980
- Strain Relief Clamp

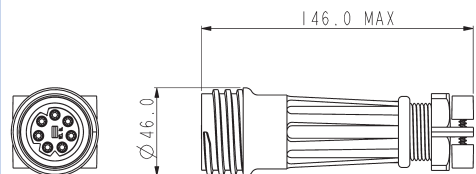

Standard Cable	Large Cable	Description	Standard Cable	Large Cable	Description
EXP-0921/02/P	EXP-A921/02/P	2 Contact Plug	EXP-0921/02/S	EXP-A921/02/S	2 Contact Socket
EXP-0921/03/P	EXP-A921/03/P	3 Contact Plug	EXP-0921/03/S	EXP-A921/03/S	3 Contact Socket
EXP-0921/04/P	EXP-A921/04/P	4 Contact Plug	EXP-0921/04/S	EXP-A921/04/S	4 Contact Socket
EXP-0921/05/P	EXP-A921/05/P	5 Contact Plug	EXP-0921/05/S	EXP-A921/05/S	5 Contact Socket
EXP-0921/07/P	EXP-A921/07/P	7 Contact Plug	EXP-0921/07/S	EXP-A921/07/S	7 Contact Socket
EXP-0921/10/P	EXP-A921/10/P	10 Contact Plug	EXP-0921/10/S	EXP-A921/10/S	10 Contact Socket

Front Panel Mounting Connector



EXP-0931

- Mates with EXP-0911 and EXP-A911 connectors
- Single hole fixing
- Anti-rotation key
- High grade sealing gasket
- 3-7mm panel thickness

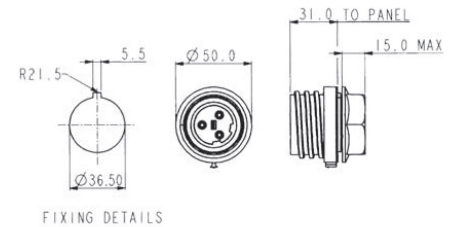

Panel Mounting

EXP-0931/02/P	2 Contact Plug	EXP-0931/02/S	2 Contact Socket
EXP-0931/03/P	3 Contact Plug	EXP-0931/03/S	3 Contact Socket
EXP-0931/04/P	4 Contact Plug	EXP-0931/04/S	4 Contact Socket
EXP-0931/05/P	5 Contact Plug	EXP-0931/05/S	5 Contact Socket
EXP-0931/07/P	7 Contact Plug	EXP-0931/07/S	7 Contact Socket
EXP-0931/10/P	10 Contact Plug	EXP-0931/10/S	10 Contact Socket

Flange Mounting Connector



EXP-0941

- Mates with EXP-0911 and EXP-A911 connectors
- Supplied with high grade sealing gasket
- Supplied with sealing grommets for panel fixing screws (M6 thread recommended)

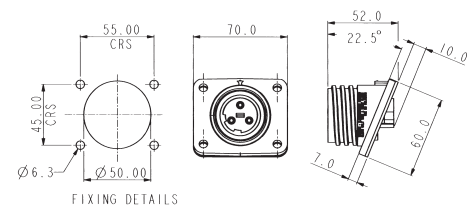

Panel Mounting

EXP-0941/02/P	2 Contact Plug	EXP-0941/02/S	2 Contact Socket
EXP-0941/03/P	3 Contact Plug	EXP-0941/03/S	3 Contact Socket
EXP-0941/04/P	4 Contact Plug	EXP-0941/04/S	4 Contact Socket
EXP-0941/05/P	5 Contact Plug	EXP-0941/05/S	5 Contact Socket
EXP-0941/07/P	7 Contact Plug	EXP-0941/07/S	7 Contact Socket
EXP-0941/10/P	10 Contact Plug	EXP-0941/10/S	10 Contact Socket

Sealing Caps



EXP-0990, EXP-0991, EXP-0992

- Heavy duty sealing caps to maintain IP68 rating of unmated connectors, with stainless steel straps

Sealing Caps

EXP-0990	Heavy duty sealing cap for use with EXP-0911/xx/x and EXP-A911/xx/x
EXP-0991	Heavy duty sealing cap for use with EXP-0921/xx/x and EXP-A921/xx/x
EXP-0992	Heavy duty sealing cap for use with EXP-0931 and EXP-0941

Cable Glands



PX0980, PXA980

- Packs of 3 additional pairs Cable Glands for 900 Series Flex Cable Connectors

Gland Packs

EXP-0980	Pack of 3 additional cable glands for EXP-0911 and EXP-0921 to suit cable sizes: 7-9mm (Dark Grey), 9-11mm (White) and 11-13mm (Black) diameter
EXP-A980	Pack of 3 additional cable glands for EXP-A911 and EXP-A921 to suit cable sizes: 14-16mm (Dark Grey), 16-18mm (White) and 18-20mm (Black) diameter

EXP-X9	X	X	/	XX	/	X	/	X
---------------	----------	----------	----------	-----------	----------	----------	----------	----------

Series Designation

09 = Standard Cable Accommodation (ø7-15mm)

A9 = Large Cable Accommodation (ø14-22mm)

Body Styles

- 1 = Flex,
- 2 = Inline,
- 3 = Front Panel,
- 4 = Flange Panel

Contact Termination

- 1 = Screw Terminal

Number of Contacts

- 02
- 03
- 04
- 05
- 07
- 10

Contact Type

P = Plug, S = Socket

Cable Acceptance

EXP-0 version:
Blank = 13-15mm
Yellow cable gland (std)

3 = 11-13mm
Black cable gland

2 = 9-11mm
White cable gland

1 = 7-9mm
Dark Grey cable gland

EXP-A version:
Blank = 20-22mm
Yellow cable gland (std)

9 = 18-20mm
Black cable gland

8 = 16-18mm
White cable gland

7 = 14-16mm
Dark Grey cable gland

Example:

EXP-0911/07/P/3 = Flex cable connector body, seven Plug contacts, with gland to suit 11-13mm cable.

Contact Layout



2 Contact



3 Contact



4 Contact



5 Contact



7 Contact

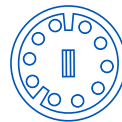

10 Contact

Overall dimensions of connectors when mated together:

EXP-0911 + EXP-0921	230 mm max.	EXP-A911 + EXP-A931	175 mm max. (to panel)
EXP-A911 + EXP-A921	270 mm max.	EXP-0911 + EXP-0941	145 mm max. (to panel, mid point on flange)
EXP-0911 + EXP-0931	135 mm max. (to panel)	EXP-A911 + EXP-A941	174 mm max. (to panel, mid point on flange)

**Electrical:**

No Contacts:	2, 3, 4, 5	7	10
Current Rating:	18A	16A	10A
Voltage Rating:	600V AC/DC 430V AC/DC 250V AC/DC		
Contact Resistance:	<10mΩ (initial)		
Insulation Resistance:	>10 ⁹ MΩ (@ 500V DC)		
Dielectric strength:	2.2kV DC min		
AC Breakdown voltage:	6kV		
Ambient Temperature Range:	-20°C to +55°C		
Standards:	ATEX Zone 2 and Zone 22 IEC60079-0:2007 IEC60079-15:2005		
ATEX Coding:	Ⓔ II 3 GD		
ATEX Certificate No:	Baseefa09ATEX0232X		
ATEX Classification:	Ex nA IIC T6 Gc Ex tc IIIC T85°C Dc		

Materials:

Body Mouldings:	Polyester
Cap Mouldings:	Polycarbonate
Flammability Rating:	UL94V-0
UV Resistance:	To EN50021:1999
Contacts:	Machined Solid Brass, Nickel plated
O Rings:	Nitrile Panel
Sealing Gasket:	Silicone Rubber
RoHS	Compliant

Mechanical:

Sealing:	IP68, EN60529:2001 tested @ 1.054kg/sq.cm. (15lb/sq.in.) 10m depth for 2 weeks
Cable Acceptance:	EXP-0911 - EXP-0921 13 - 15mm O/D standard, 7-13mm with Gland Pack PX0980 EXP-A911 - EXP-A921 20 - 22mm O/D standard, 14 - 20mm with Gland Pack PXA980
Contact Accommodation:	2-7 Contact - 2.5 to 4mm ² (14 to 10AWG) conductor, single or multi stranded 10 Contact - 0.75 to 2mm ² (14 to 18AWG) conductor, single or multi stranded
Termination:	Axial screw terminals 22mm dia, 150N
Cable Retention force:	15mm dia, 150N 7mm dia, 80N
Gland Nut Torques:	
EXP-0 range	3.16Nm (28lbf/in)
13-15mm (Yellow - std.)	3.16Nm (28lbf/in)
11-13mm (black)	3.16Nm (28lbf/in)
9-11mm (white)	3.16Nm (28lbf/in)
7-9mm (dark grey)	
EXP-A range	
20-22mm (Yellow - std.)	3.16Nm (28lbf/in)
18-20mm (black)	3.16Nm (28lbf/in)
16-18mm (white)	3.16Nm (28lbf/in)
14-16mm (dark grey)	3.16Nm (28lbf/in)
Tightening Torques:	
Panel mount nut	2.25Nm
Flange & Bulkhead fixing screws	0.9Nm
Rear thread EXP-0931 series	M36 x 2-6g



- IP68 rating tested at 1.054kg/sq cm (15lb/sq in) 10m depth for 2 weeks
- IP69K, Tested in accordance with DIN 40050/Part 9 IP6k9K
- 32A, 600V AC/DC rating
- 2, 3, 4, 5, 7 and 10 Contact
- Plug or socket connection in each body style
- Water and dustproof to IP68 when mated
- 'Scoop proof' contacts
- Field termination - screw terminations
- Positive locating keyways - cannot be mis-connected
- Sealing caps available to maintain IP68 rating of unmated connectors
- Leading earth contact for 3, 4, 5 and 7 Contact versions
- EN60068-2-52 Test Kb Salt Mist (Cyclic) Marine Severity Level 1
- Trailing Neutral on 5 Contact
- Compact design
- Easy assembly - no special tools required
- Single or 3 phase applications
- Bulkhead moulding available for use with flange mounting body for 45° or 90° mounting (order each separately)
- Cost effective solution
- Cable accommodation 7-22mm O/D
- Two cable connector versions for 15mm and 22mm (maximum) cable diameters
- Separate strain relief on large cable version
- VDE and cULus approvals

Flex Cable Connector



PX0911

Flex Cable Connector



PXA911

- Mates with Inline or panel mounting versions
- Positive, fast acting locking ring - can be turned with a gloved hand
- Plug or socket versions
- PX0 Series 13-15mm cable dia. as standard, 7-13mm with additional Gland Pack PX0980
- PXA Series 20-22mm cable dia. as standard, 14-20mm with additional Gland Pack PXA980
- Strain Relief Clamp

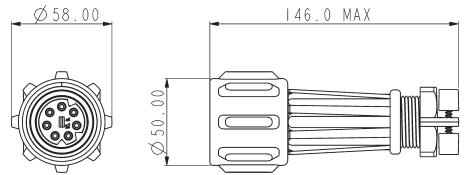
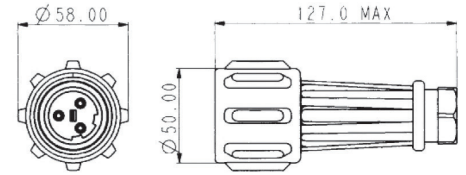

Standard Cable	Large Cable	Description	Standard Cable	Large Cable	Description
PX0911/02/P	PXA911/02/P	2 Contact Plug	PX0911/02/S	PXA911/02/S	2 Contact Socket
PX0911/03/P	PXA911/03/P	3 Contact Plug	PX0911/03/S	PXA911/03/S	3 Contact Socket
PX0911/04/P	PXA911/04/P	4 Contact Plug	PX0911/04/S	PXA911/04/S	4 Contact Socket
PX0911/05/P	PXA911/05/P	5 Contact Plug	PX0911/05/S	PXA911/05/S	5 Contact Socket
PX0911/07/P	PXA911/07/P	7 Contact Plug	PX0911/07/S	PXA911/07/S	7 Contact Socket
PX0911/10/P	PXA911/10/P	10 Contact Plug	PX0911/10/S	PXA911/10/S	10 Contact Socket

Inline Cable Connector



PX0921

Inline Cable Connector



PXA921

- Mates with either PX0911 or PXA911 connectors
- Plug or socket versions
- PX0 Series 13-15mm cable dia. as standard, 7-13mm with additional Gland Pack PX0980
- PXA Series 20-22mm cable dia. as standard, 14-20mm with additional Gland Pack PXA980
- Strain Relief Clamp

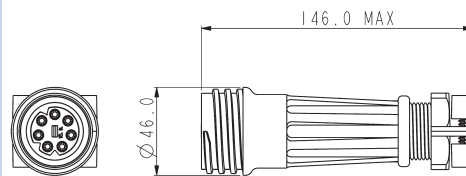
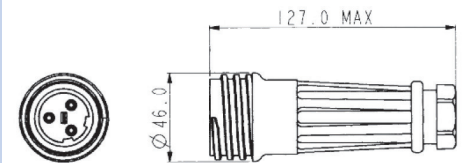

Standard Cable	Large Cable	Description	Standard Cable	Large Cable	Description
PX0921/02/P	PXA921/02/P	2 Contact Plug	PX0921/02/S	PXA921/02/S	2 Contact Socket
PX0921/03/P	PXA921/03/P	3 Contact Plug	PX0921/03/S	PXA921/03/S	3 Contact Socket
PX0921/04/P	PXA921/04/P	4 Contact Plug	PX0921/04/S	PXA921/04/S	4 Contact Socket
PX0921/05/P	PXA921/05/P	5 Contact Plug	PX0921/05/S	PXA921/05/S	5 Contact Socket
PX0921/07/P	PXA921/07/P	7 Contact Plug	PX0921/07/S	PXA921/07/S	7 Contact Socket
PX0921/10/P	PXA921/10/P	10 Contact Plug	PX0921/10/S	PXA921/10/S	10 Contact Socket

Front Panel Mounted Connector



PX0931

- Mates with PX0911 and PXA911 connectors
- Single hole fixing
- Anti-rotation key
- High grade sealing gasket
- 3-7mm panel thickness

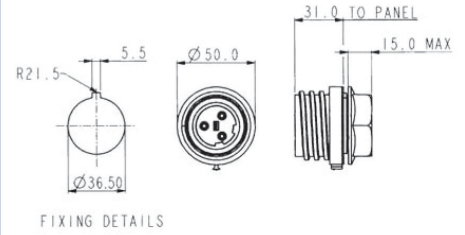

Panel Mounting

PX0931/02/P	2 Contact Plug	PX0931/02/S	2 Contact Socket
PX0931/03/P	3 Contact Plug	PX0931/03/S	3 Contact Socket
PX0931/04/P	4 Contact Plug	PX0931/04/S	4 Contact Socket
PX0931/05/P	5 Contact Plug	PX0931/05/S	5 Contact Socket
PX0931/07/P	7 Contact Plug	PX0931/07/S	7 Contact Socket
PX0931/10/P	10 Contact Plug	PX0931/10/S	10 Contact Socket

Flange Mounted Connector



PX0941

- Mates with PX0911 and PXA911 connectors
- Supplied with high grade sealing gasket
- Supplied with sealing grommets for panel fixing screws (M6 thread recommended)

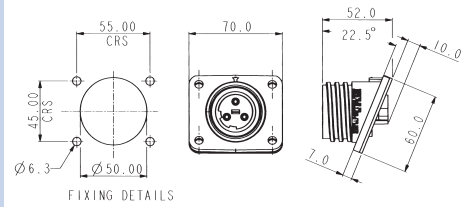

Flange Mounting

PX0941/02/P	2 Contact Plug	PX0941/02/S	2 Contact Socket
PX0941/03/P	3 Contact Plug	PX0941/03/S	3 Contact Socket
PX0941/04/P	4 Contact Plug	PX0941/04/S	4 Contact Socket
PX0941/05/P	5 Contact Plug	PX0941/05/S	5 Contact Socket
PX0941/07/P	7 Contact Plug	PX0941/07/S	7 Contact Socket
PX0941/10/P	10 Contact Plug	PX0941/10/S	10 Contact Socket

Additional Bulkhead Adaptor Moulding



PX0950

Additional Bulkhead Adaptor Moulding



PX0950 & PX0941

- For use with flange mounting connector PX0941, to give 45° or 90° angle
- Supplied with high grade sealing gasket
- Supplied with sealing grommets for panel fixing screws (M6 thread recommended)

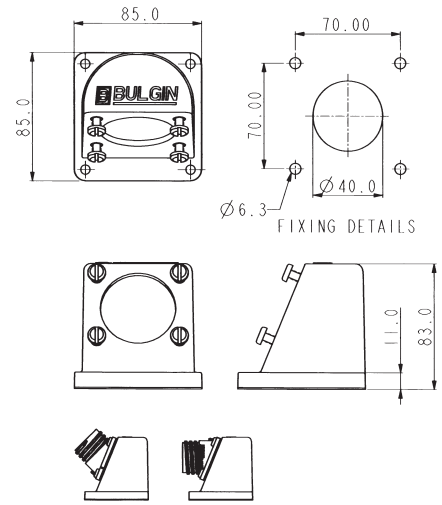

Sealing Caps



PX0960, PX0970, PX0990, PX0991, PX0992

- Sealing caps to maintain IP68 rating of unmated connectors, with plastic straps
- Heavy duty sealing caps to maintain IP68 rating of unmated connectors, with stainless steel straps

Sealing Caps

- PX0960 Sealing cap for use with PX0911/xx/x and PXA911/xx/x
- PX0970 Sealing cap for use with all other styles
- PX0990 Heavy duty sealing cap for use with PX0911/xx/x and PXA911/xx/x
- PX0991 Heavy duty sealing cap for use with PX0921/xx/x and PXA921/xx/x
- PX0992 Heavy duty sealing cap for use with PX0931Wand PX0941

Cable Glands



PX0980, PXA980

- Packs of 3 additional pairs Cable Glands

Gland Packs

- PX0980 Pack of 3 additional cable glands for PX0911 and PX0921 to suit cable sizes: 7-9mm (dark grey), 9-11mm (white) and 11-13mm (Black) diameter
- PXA980 Pack of 3 additional cable glands for PXA911 and PXA921 to suit cable sizes: 14-16mm (dark grey), 16-18mm (white) and 18-20mm (black) diameter

BUCCANEER FOR POWER

900 Series Buccaneer



Specifications

Electrical

No Contacts:	2, 3	4, 5	7	10†
Current Rating:	32A 30A, CSA	32A 25A, CSA	32A 25A, CSA*	10A UL
Voltage Rating:	600V AC/DC	600V AC/DC	430V AC/DC	250V AC/DC
Contact Resistance:	<10m Ω (initial)			
Insulation Resistance:	>10 ⁶ MΩ @ 500V DC)			
Dielectric strength:	2.2kV AC min			
AC Breakdown voltage:	6kV			
Operating Temperature Range:	-40°C to +85°C			
Approvals:	<ul style="list-style-type: none"> cULus (Underwriters Laboratory) E214972 VDE (Verband der Elektrotechnik) 1211899 40003148 			

*with 75°C min. rated cable

Mechanical:

Sealing:	IP69K, Tested in accordance with DIN 40050/Part 9 IP6K9K.
	IP68, EN60529:1992+A2:2013 tested @ 1.054kg/sq.cm. (15lb/sq.in.) 10m depth for 2 weeks
Salt Mist:	EN60068-2-52 Test Kb Salt Mist (Cyclic) Marine Severity Level 1
Cable Acceptance:	PX0911-PX0921 13 - 15mm O/D standard, 7-13mm with gland pack PX0980 PXA911-PXA921 20 - 22mm O/D standard, 14 - 20mm with gland pack PXA980
Contact Accommodation:	2-7 Contact - 2.5 to 4mm ² (14 to 10AWG) conductor, single or multi stranded 10 Contact - 0.75 to 2.5mm ² (14 to 18AWG) conductor, single or multi stranded
Termination:	Axial screw terminals

Material

Body Mouldings:	Polyamide
Flammability Rating:	UL94V-0
UV Resistance:	To EN50021: 1999
Contacts:	Machined Solid Brass, Nickel plated
O Rings:	Nitrile
Panel Sealing Gasket:	Silicone Rubber
RoHS	Compliant

Cable Retention force:	22mm dia, 150N 15mm dia, 150N 7mm dia, 80N
------------------------	--

Gland Nut Torques:	
PX0 range	
13-15mm (Yellow - std.)	3.16Nm (28 lbf.in.)
11-13mm (black)	3.16Nm (28 lbf.in.)
7-9mm (dark grey)	3.16Nm (28 lbf.in.)
PXA range	
20-22mm (Yellow - std.)	3.16Nm (28 lbf.in.)
18-20mm (black)	3.16Nm (28 lbf.in.)
16-18mm (white)	3.16Nm (28 lbf.in.)
14-16mm (dark grey)	3.16Nm (28 lbf.in.)

Contact Layout

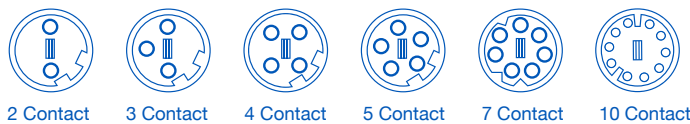

Tightening Torques:	
Panel mount nut	2.25Nm (20 lbf.in.)
Flange & Bulkhead fixing screws	0.9Nm (8 lbf.in.)
Inserts into Bodies	1.13Nm (10 lbf.in.) to 1.36Nm (12 lbf.in.)
Term screws - 2 to 5 Contacts	1.0Nm (9 lbf.in.) max
Term screws - 7 Contact	0.4Nm (3.5 lbf.in.) max
Term screws - 10 Contact	0.25Nm (2.2 lbf.in.) max

Dimensions

Overall dimensions of connectors when mated together

PX0911 + PX0921 230 mm max.
PXA911 + PXA921 270 mm max.

PX0911 + PX0931 135 mm max. (to panel)
PXA911 + PX0931 175 mm max. (to panel)

PX0911 + PX0941 145 mm max. (to panel, mid point on flange)

PXA911 + PX0941 174 mm max. (to panel, mid point on flange)

Rear thread PX0931 series M36 x 2-6g

PXX9	X	X	/	XX	/	X	/	XX
Series Designation	Body Styles	Contact Termination		Number of Contacts		Contact Type		Cable Acceptance
09 = Standard Cable Accommodation (ø7-15mm) A9 = Large Cable Accommodation (ø14-22mm)	1 = Flex 2 = Inline 3 = Front Panel 4 = Flange Panel	1 = Screw Terminal		02 03 04 05 07 10		P = Plug, S = Socket		PX-0 version: Blank = 13-15mm Yellow cable gland (std) 03 = 11-13mm Black cable gland 02 = 9-11mm White cable gland 01 = 7-9mm Dark Grey cable gland PX-A version: Blank = 20-22mm Yellow cable gland (std) 09 = 18-20mm Black cable gland 08 = 16-18mm White cable gland 07 = 14-16mm Dark Grey cable gland
Example: PX0911/07/P/03 = Flex cable connector with standard cable accommodation body, seven Plug contacts, with gland to suit 11-13mm cable.								



- IP68 rating tested at 1.054kg/sq cm (15lb/sq in) 10m depth for 2 weeks and 9.84kg/sq cm (140lb/sq in) 100m depth for 12 hours
- IP69K, Tested in accordance with DIN 40050/Part 9 IP6k9K
- Water and dustproof to IP68 when mated
- 2, 3, 4, 6, 7, 9, 12 and 25 Contact
- 12A, 277V AC/DC 2 Contact screw terminal, 3 Contact screw terminal and crimp contacts
- 10A, 277V AC/DC 4 Contact screw terminal
- 5A, 277V AC/DC 6 and 7 Contact screw terminal
- 5A, 150V AC/DC 9 Contact crimp contacts
- 5A, 50V AC/DC 12 Contact crimp and solder contacts
- 1A, 50V AC/DC 25 Contact crimp and solder contacts
- Plug or socket connection in each body style
- Compact design
- Diameter over coupling ring 38mm
- Sealing caps available to maintain IP68 rating of unmated connectors
- 7 body styles - flex cable, inline cable, panel mount (front), panel mount (rear), PCB mount, bulkhead and flange mount
- Leading earth contact for 3 Contact socket version
- Positive locating keyways - cannot be mis-connected
- Easy assembly - no special tools required on screw terminal versions
- Cable range from 3.5mm - 9mm
- Colour coded identification variants
- Pre-wired, overmoulded cable assemblies
- VDE and cULus approvals
- EN60068-2-52 Test Kb Salt Mist (Cyclic) Marine Severity Level 1

Flex Cable Connector



PX0731/P

- Mates with Inline or Panel Mounting Versions
- Screw Locking Ring
- Plug or Socket Versions
- Leading Earth on 3 Contact connectors
- Contacts 2, 3, 4, 6, 7, 9, 12, 25
- Standard Cable Acceptance (2 to 9 Contact) 6-8mm, 3.5-9mm with alternative glands - See page 25

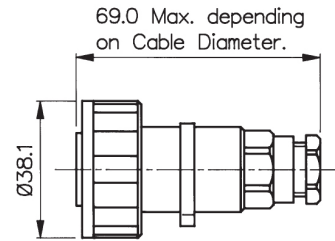

Contacts	Termination	Plug Contacts	Socket Contact	Contacts
2	Screw	PX0736/P	PX0736/S	Supplied Fitted
3	Screw	PX0731/P	PX0731/S	Supplied Fitted
3	Crimp	PX0776/P	PX0776/S	Supplied Loose
4	Screw	PX0748/P	PX0748/S	Supplied Fitted
6	Screw	PX0739/P	PX0739/S	Supplied Fitted
7	Screw	PX0745/P	PX0745/S	Supplied Fitted
9	Crimp	PX0728/P	PX0728/S	Supplied Loose
12	Crimp/Solder	PX0794/P	PX0794/S	Order Separately (SA3348/SA3347)
25	Crimp/Solder	PX0820/P	PX0820/S	Order Separately (SA3180/SA3179)

Inline Cable Connector



PX0732/S

- Mates with Flex or Panel Mounting Versions
- Screw Locking Ring
- Plug or Socket Versions
- Leading Earth on 3 Contact connectors
- Contacts 2, 3, 4, 6, 7, 9, 12, 25
- Standard Cable Acceptance (2 to 9 Contact) 6-8mm, 3.5-9mm with alternative glands - See page 25

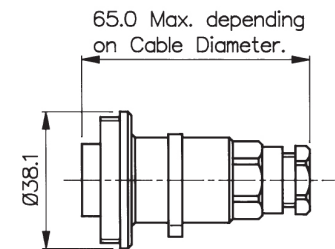

Contacts	Termination	Plug Contacts	Socket Contact	Contacts
2	Screw	PX0737/P	PX0737/S	Supplied Fitted
3	Screw	PX0732/P	PX0732/S	Supplied Fitted
3	Crimp	PX0778/P	PX0778/S	Supplied Loose
4	Screw	PX0749/P	PX0749/S	Supplied Fitted
6	Screw	PX0740/P	PX0740/S	Supplied Fitted
7	Screw	PX0746/P	PX0746/S	Supplied Fitted
9	Crimp	PX0729/P	PX0729/S	Supplied Loose
12	Crimp/Solder	PX0795/P	PX0795/S	Order Separately (SA3348/SA3347)
25	Crimp/Solder	PX0821/P	PX0821/S	Order Separately (SA3180/SA3179)

Pre Wired Flex Cable Connector



PX0700

- Overmoulded cable assemblies
- Up to 14mm dia cable with PVC or PU jackets
- Mates with Inline connector and all panel connectors

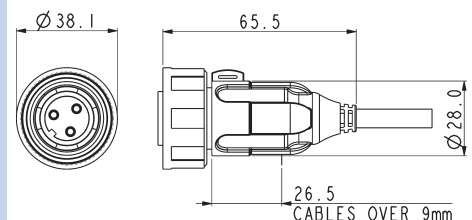

Front Panel Mounting Connector



PX0730/P

- Mates with Flex Cable Connector
- Single Hole Fixing
- Plug or Socket Versions
- Contacts 2, 3, 4, 6, 7, 9, 12, 25

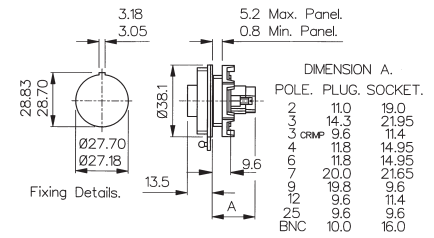

Contacts	Termination	Plug Contacts	Socket Contact	Contacts
2	Screw	PX0735/P	PX0735/S	Supplied Fitted
3	Screw	PX0730/P	PX0730/S	Supplied Fitted
3	Crimp	PX0779/P	PX0779/S	Supplied Loose
4	Screw	PX0747/P	PX0747/S	Supplied Fitted
6	Screw	PX0738/P	PX0738/S	Supplied Fitted
7	Screw	PX0744/P	PX0744/S	Supplied Fitted
9	Crimp	PX0727/P	PX0727/S	Supplied Loose
12	Crimp/Solder	PX0796/P	PX0796/S	Order Separately
25	Crimp/Solder	PX0822/P	PX0822/S	Order Separately

Rear Panel Mounting Connector



PX0709/P/03

- Mates with Flex Cable Connector
- Single Hole Fixing
- Plug or Socket Versions
- Contacts 2, 3, 4, 6, 7, 9, 12 or 25

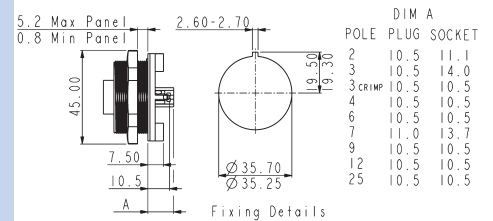

Contacts	Termination	Plug Contacts	Socket Contact	Contacts
2	Screw	PX0709/P/02	PX0709/S/02	Supplied Fitted
3	Screw	PX0709/P/03	PX0709/S/03	Supplied Fitted
3	Crimp	PX0708/P/03	PX0708/S/03	Supplied Loose
4	Screw	PX0709/P/04	PX0709/S/04	Supplied Fitted
6	Screw	PX0709/P/06	PX0709/S/06	Supplied Fitted
7	Screw	PX0709/P/07	PX0709/S/07	Supplied Fitted
9	Crimp	PX0708/P/09	PX0708/S/09	Supplied Loose
12	Crimp/Solder	PX0708/P/12	PX0708/S/12	Order Separately (SA3348/SA3347)
25	Crimp/Solder	PX0708/P/25	PX0708/S/25	Order Separately (SA3180/SA3179)

Sprung Loaded Sealing Cap



PX0713

- IP54 rated
- Spring loaded
- Clip shut to seal
- For use with front of panel mounting connector types

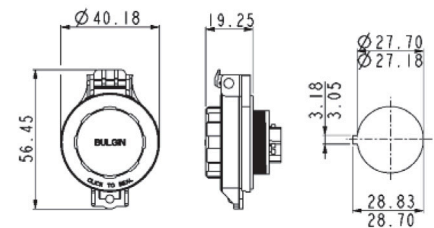

Rear PCB Mounting Connector



PX0707/P/12

- Mates with Flex Cable connector
- No. Contacts: 3, 4, 6, 9, 12 or 25
- Plug or socket versions
- Pre-loaded Gold Plated contacts

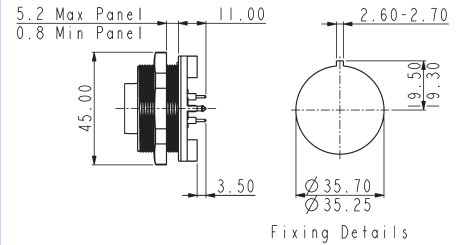

Contacts	Termination	Plug Contacts	Socket Contact	Contacts
3	PCB	PX0707/P/03	PX0707/S/03	Supplied Fitted
4	PCB	PX0707/P/04	PX0707/S/04	Supplied Fitted
6	PCB	PX0707/P/06	PX0707/S/06	Supplied Fitted
9	PCB	PX0707/P/09	PX0707/S/09	Supplied Fitted
12	PCB	PX0707/P/12	PX0707/S/12	Supplied Fitted
25	PCB	PX0707/P/25	PX0707/S/25	Supplied Fitted

Bulkhead Flange Mounting Connector



PX0756/S

- Mates with Flex Cable Connector
- Plug or Socket Versions
- Contacts 2, 3, 4, 6, 7, 9, 12, 25
- Supplied with sealing gasket and screw sealing grommets

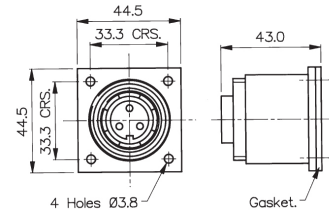

Contacts	Termination	Plug Contacts	Socket Contact	Contacts
2	Screw	PX0757/P	PX0757/S	Supplied Fitted
3	Screw	PX0756/P	PX0756/S	Supplied Fitted
3	Crimp	PX0787/P	PX0787/S	Supplied Loose
4	Screw	PX0761/P	PX0761/S	Supplied Fitted
6	Screw	PX0758/P	PX0758/S	Supplied Fitted
7	Screw	PX0760/P	PX0760/S	Supplied Fitted
9	Crimp	PX0762/P	PX0762/S	Supplied Loose
12	Crimp/Solder	PX0798/P	PX0798/S	Order Separately (SA3348/SA3347)
25	Crimp/Solder	PX0823/P	PX0823/S	Order Separately (SA3180/SA3179)

Low Profile Flange Mounting Connector



PX0765/S

- Screw Flange Fixing
- Plug or Socket Versions
- Contacts 2, 3, 4, 6, 7, 9, 12, 25
- Mates with Flex Cable Connector
- Supplied with sealing gasket and screw sealing grommets

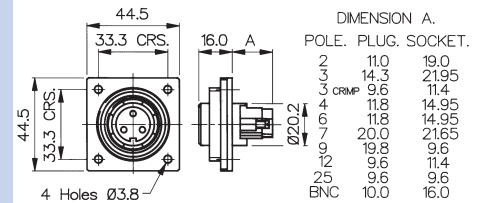

Contacts	Termination	Plug Contacts	Socket Contact	Contacts
2	Screw	PX0764/P	PX0764/S	Supplied Fitted
3	Screw	PX0765/P	PX0765/S	Supplied Fitted
3	Crimp	PX0781/P	PX0781/S	Supplied Loose
4	Screw	PX0766/P	PX0766/S	Supplied Fitted
6	Screw	PX0767/P	PX0767/S	Supplied Fitted
7	Screw	PX0768/P	PX0768/S	Supplied Fitted
9	Crimp	PX0769/P	PX0769/S	Supplied Loose
12	Crimp/Solder	PX0797/P	PX0797/S	Order Separately (SA3348/SA3347)
25	Crimp/Solder	PX0824/P	PX0824/S	Order Separately (SA3180/SA3179)

Coloured Contact Inserts



Coloured Inserts

- With or without matching gland nut
- Positive visual identification
- Available in; Black, Blue, Green, Grey, Light Grey, Red, White and Yellow

Contact Inserts Colour Options

Part No	Suffix Colour
Blank	Black
BL	Blue
GN	Green
GY	Grey
LG	Light Grey
RD	Red
WH	White
YL	Yellow

Insert/Gland Nut Combinations

1	Insert and Gland Nut Coloured
2	Insert Only Coloured

E.g. PX0731/P/YL1 = Yellow insert and gland nut

Contacts for 12 and 25 Contact Inserts



12 and 25 way contacts

- Crimp or Solder Plugs and Sockets
- Gold Plated
- Current ratings:
 12 way: 5A, 50V
 25 way: 1A, 50V

Contacts - Solder & Crimp for 12 and 25 Contact

Contacts (for 12 Contact) (Supplied in packs of 10)	Solder	Crimp
Plugs	SA3348/1	SA3348
Sockets	SA3347/1	SA3347
Contacts (for 25 Contact) (Supplied in packs of 10)	Solder	Crimp
Plugs	SA3180/1	SA3180
Sockets	SA 3179/1	SA3179

Assembly Tools



PNo 14025 and 13027

- Crimp Tools for 3, 9, 12 and 25 Contact crimp contacts
- Insertion/Extraction Tool for 25 Contact contacts

Tools

Crimp Tool (25 Contact)	PNo. 14025/1AMP
Crimp Tool (12 Contact)	PNo. 14025
Positioner (12 Contact)	PNo. 14025/5AMP
Crimp Tool (9 Contact)	PNo. 13826
Crimp Tool (3 Contact)	PNo. 14232
3 Contact positioner	PNo. 14232/1
Insertion/Extraction Tool (25 Contact)	PNo. 13027
Insertion/Extraction Tool (12 Contact)	PNo. 13027/1
Insertion/Extraction Tool (3 Contact)	PNo. 13027/3

Cable Glands



12023/1, 12023/2 & SA3253

- Pack of alternative cable glands to suit cables from 3.5 to 9mm dia.

Cable Acceptance - Alternatives

Gland Diameter	Gland Part No.	Gland Colour	Additional Suffix
6-8mm	12023	Black	Standard for 2-12 Contact
3.5-5mm	SA3426	Grey	Suffix /04†
5-7mm	12023/1	White	Suffix /05
7-9mm	12023/2	Yellow	Suffix /07*
Gland Pack	SA3253		Pack of 3 glands to suit cables 3.5-5mm, 5-7mm & 7-9mm dia†

*Note: 7-9mm gland standard for 25 way, no suffix required.
 †Includes additional black gland cage for 3.5-5mm dia. cable range.

To order connector with alternative cable gland add suffix to part no. e.g. PX0731/P/07 = PX0731 3 Plug connector with cable gland to suit 7-9mm dia. cable.

Cable Acceptance - Standard as supplied

No. Contacts	Cable Diameter or Type
2-12 Contact	6-8mm
25 Contact	7-9mm

Sealing Cap and Assembling Tool



PX0734 & PX0733

- Maintains IP68 Rating of Unmated Connectors
- Can be used to remove Inserts
- PX0734 for Flex Cable Connector
- PX0733 for Inline, Front Panel, Bulkhead and Flange mount connectors
- PX0711 for PCB and Rear Panel Mount connectors

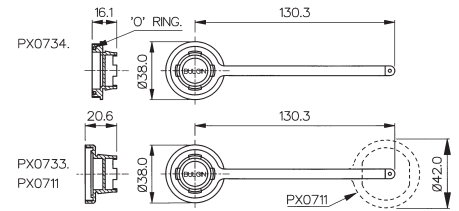

Rear of Panel Back Shell



PX0799

- Provides environmental seal to rear of panel
- Standard cable acceptance 6-8mm, 3.5 to 9mm with alternative glands
- For use on front panel mounting connectors
- Replaces mounting nut in panel connector

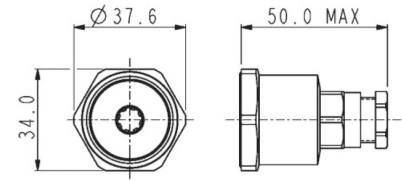

PVC Insulation Boot



PNo. 12855

- Shock protection for rear of connector
- Flammability Rating UL94V-0
- Fits Front Panel Mount Versions only

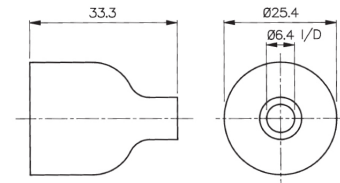

Cable Support Accessory



PNo. 12237

- Gives Extra Support to the Cable
- Suitable for 5-7mm and 7-9mm Cable Diameters

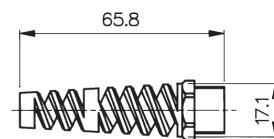

PX07XX	X	XX	XX	X
Body Styles	Contacts Type	Cable Acceptance or PCB/Rear Panel Mounting	Insert/Gland Nut Colour	Insert/Gland Nut Colour Combination
PX0736 PX0731 PX0776 PX0748 PX0739 PX0745 PX0728 PX0794 PX0820 PX0737 PX0732 PX0778 PX0749 PX0740 PX0746 PX0729 PX0795 PX0821 PX0735 PX0730 PX0779 PX0747 PX0738 PX0744 PX0727 PX0796 PX0822 PX0709 PX0708 PX0707 PX0757 PX0756 PX0787 PX0761 PX0758 PX0760 PX0762 PX0798 PX0823 PX0764 PX0765 PX0781 PX0766 PX0767 PX0768 PX0769 PX0797 PX0824	P = Plug S = Socket	Flex Cable and Inline Connectors cable acceptance use: Blank = 6-8mm (Black) standard for 2-12 Contact 04 = 3.5-5mm (Grey) 05 = 5-7mm (White) 07 = 7-9mm (Yellow) (standard for 25 way, no suffix required) PCB (PX0707) and Rear Panel Mount connectors (PX0708 and PX0709) use: 02 = 2 Contact 03 = 3 Contact 04 = 4 Contact 06 = 6 Contact 07 = 7 Contact 09 = 9 Contact 12 = 12 Contact 25 = 25 Contact Front Panel, Bulkhead and Flange Mount - not required:	Blank = Black BL = Blue GN = Green GY = Grey LG = Light Grey RD = Red WH = White YL = Yellow	1 = Insert and Gland Nut Coloured 2 = Insert only Coloured
<p>Examples:</p> <p>PX0707/P/06= PCB Panel connector, Plug contacts, 6 Contact PX0731/S = Flex Cable connector, socket contacts, 3 Contact PX0732/P/07/BL2 = Inline Cable connector, Plug contacts, 3 Contact, 7-9mm cable acceptance, blue insert</p>				

PCB Layouts

Sockets

Contact Nos viewed from rear of panel

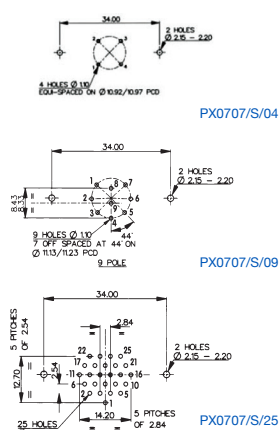
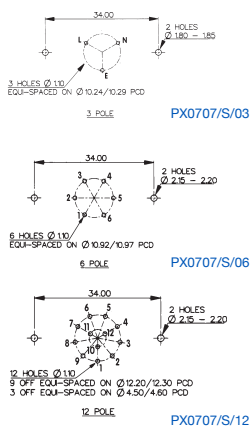

Plugs

Contact Nos viewed from rear panel rear of panel

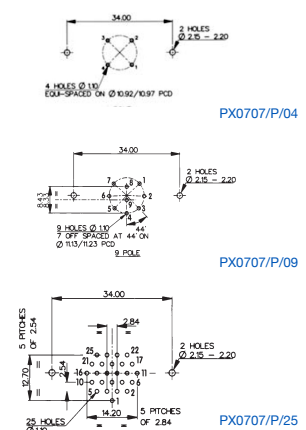
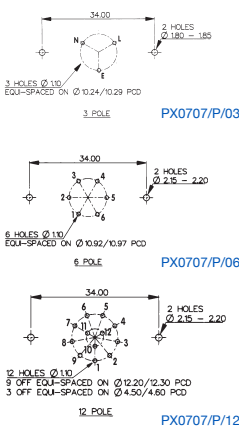

Electrical:

No. Contacts:	2, 3	4	6, 7	9	12	25
Current Rating:						
VDE	12A	10A	5A	5A	5A	1A
UL	12A	10A	5A	5A	5A	1A
Voltage Rating (AC/DC):	277V	277V	277V	150V	50V	50V
Contact Resistance:	<10mΩ (2-9 Contact)					
	<5mΩ (12 Contact)					
	<5mΩ (25 Contact)					
Insulation Resistance:	>10 ⁴ MΩ @ 500V DC (2-9 Contact)					
AC Breakdown voltage:	4kV Contact - Contact (2-9 Contact)					
	6kV Contacts - Panel (Low Profile Flange and Panel Types – 2-9 Contact)					
	7.5kV Contacts - Panel (Other Types – 2-9 Contact)					
Operating Temp. Range:	-20°C to +70°C					
Approvals:						
UL (Underwriters Laboratory)	E93288 and E337507					
VDE (Verband der Elektrotechnik)	40023148					
	Overmoulded cable assemblies approvals to customer requirements.					

Material:

Body Mouldings:	Glass Filled Polyamide UL94HB
Inserts (2-25 Contact):	Polyamide UL94V-0
PX0707	Polyamide UL94V-0
PX0708	Polyamide UL94V-0
PX0709	Polyamide UL94V-0
Overmoulded types:	
Body Mouldings:	Polyurethane
Flammability Rating:	UL94V-HB
Contacts:	
Screw Terminal:	Brass, Nickel Plated
Crimp (9 Contact):	Copper Alloy, Tin Plated
Crimp/Solder (12+25 Contact):	Copper Alloy, Gold Plated (0.1µm on Nickel)
BNC inserts:	Brass, Nickel Plated
BNC contacts:	Brass, Silver Plated
RoHS	Compliant

Mechanical:

Sealing:	IP69K, Tested in accordance with DIN 40050/Part 9 IP6k9k
	IP68, EN 60529:1992+A2:2013 Tested @ 1.054kg/sq.cm. (15lb/sq.in.) 10m depth for 2 weeks.
	EN 60529:1992 +A2:2013 Tested @ 9.84kg/sq.cm. (140lb/sq.in.) 100m depth for 12 hours.
Salt Mist:	EN60068-2-52 Test Kb Salt Mist (Cyclic) Marine Severity Level 1
Cable Acceptance:	
2-12 Contact - standard gland:	6-8mm dia
2-12 Contact - alternative glands:	3.5-9mm dia
25 Contact - standard gland:	7-9mm dim
25 Contact - alternative glands:	3.5-7mm dim
Contact Accommodation:	
2 and 3 Contact screw terminals:	2.5-4mm ² (12-14AWG)
3 Contact crimp:	1-1.5mm ² (16-17AWG)
4, 6 and 7 Contact:	1-1.5mm ² (17-16AWG)
9 Contact:	0.14-0.25mm ² (24-26AWG)
12 Contact:	0.25-0.34mm ² (22-24AWG)
25 Contact:	0.14-0.25mm ² (24-26AWG)
Terminations:	
2-7 Contact:	Screw Terminals
3 Contact:	Screw Terminals & Crimp
9 Contact:	Crimp Contacts
12 Contact:	Crimp & Solder Contacts
25 Contact:	Crimp & Solder Contacts
Tightening Torques:	
Flex Mounting/Inline:	Gland Nut: 1.13Nm (10lbf.in.)
Panel Mounting:	Rear Fixing Nut: 1.7Nm (15lbf.in.) Front Fixing Nut: 1.4Nm (12.4lbf.in.)
Surface/Bulkhead and Low Profile Flange Mounting:	4 Fixing Screws (using washers supplied) 0.34Nm (3lbf.in.)
Sealings Caps/Locking Ring:	1.13Nm (10lbf.in.)
Rear thread, Front Panel Connector:	M27 x 1.0-6H
Thread, Front Panel Connector:	M35 x 1.0-6H

Cable Joiner



PX0777

- IP68 & IP69k Rating
- For Sealed Inline Connections
- Standard Cable Acceptance 6-8mm
- Cable Range 3.5-9mm (using alternative glands)
- Supplied with 4, 6 or 8 way Terminal Block
- Terminal Block
- Available Moulded in Black or Orange

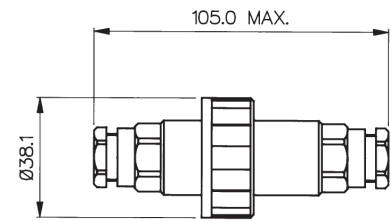

Specifications	PX0777	PX0777/4POLE, 6POLE, 8POLE	POLE Configurations
Rating:	16A, 250V AC	10A, 250V AC	
Wire Termination:	3 way Terminal Block	4, 6, 8 way Terminal Block	
Conductor Accommodation:	2.5mm ² max (14AWG)	1.5mm ² max (16AWG)	
Cable Acceptance:	6-8mm dia alternative glands available on request	6-8mm dia alternative glands available on request	
Material:	Glass Filled Polyamide UL94-HB	Glass Filled Polyamide UL94-V0	
Sealing:	IP68 to BSEN 60529 : 1992 1.054kg/sq.cm. (15lbs/sq.in.) 10m depth for 2 weeks	IP68 to BSEN 60529 : 1992 1.054kg/sq.cm. (15lbs/sq.in.) 10m depth for 2 weeks	
Salt Mist	IP69k to DIN 40050-9	IP69k to DIN 40050-9	
Operating Temp. Range:	EN60068-2-52 Test Kb Salt Mist (Cyclic) Marine Severity Level 1	EN60068-2-52 Test Kb Salt Mist (Cyclic) Marine Severity Level 1	
Colour:	-20°C to +70°C	-20°C to +70°C	
	Black Orange (Add /OR to PNo.)	Black Orange (Add /OR to PNo.)	
RoHS	Compliant	Compliant	

Examples

- PX0777 – 3 Contact 6-8mm Black.
- PX0777/04 – 3 Contact 3.5-5.0mm Black.
- PX0777/04/OR – 3 Contact 3.5-5.0mm Orange.
- PX0777/4POLE – 4 Contact 6-8mm Black.
- PX0777/6POLE/04 – 6 Contact 3.5-5.0mm Black.
- PX0777/8POLE/04/OR – 8 Contact 3.5-5.0mm Orange.

PX0777	/	XPOLE	/	XX	/	XX
Part No		Blank = 3 Contact 4POLE = 4 Contact 6POLE = 6 Contact 8POLE = 8 Contact		Blank = 6-8mm 04 = 3.5-5mm 05 = 5-7mm 07 = 7-9mm		Blank = Black OR = Orange

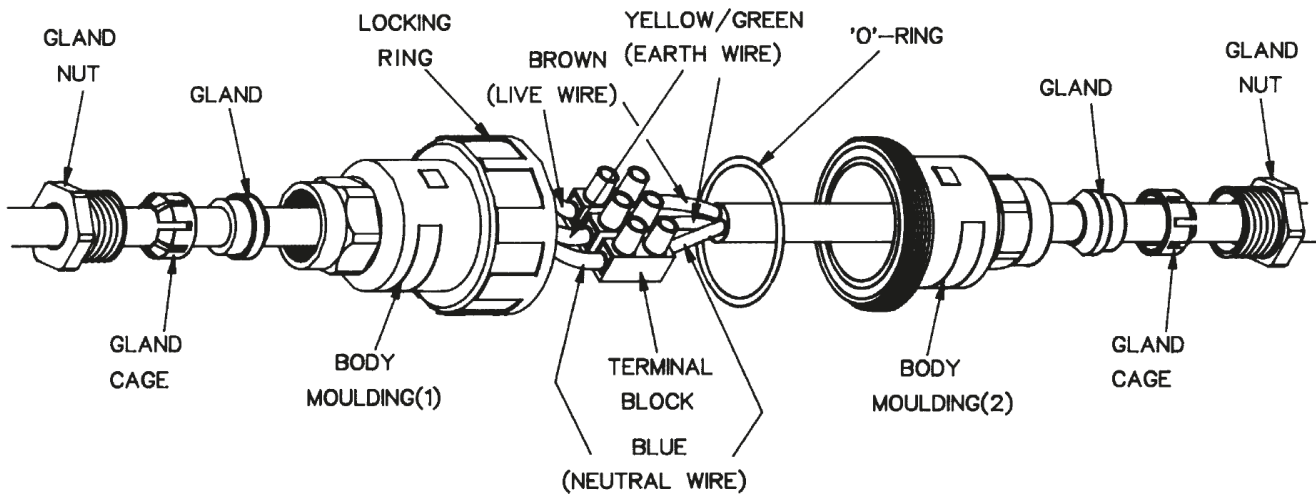

1. Strip wires to dimensions shown.
2. Assemble components parts onto cable as shown, then connect wires to terminal block.

ENSURING WIRES CONNECTED INTO ONE SIDE OF TERMINAL BLOCK MATCH WIRES CONNECTED INTO THE OTHER SIDE.

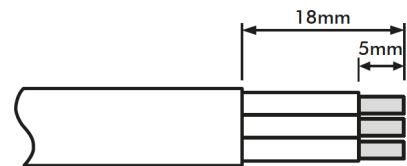

Wire stripping details

- i.e.
- Brown to Brown (Live)
 - Blue to Blue (Neutral)
 - Green/Yellow to Green/Yellow (Earth)

3. Bring the two body mouldings together ensuring the 'O' ring is correctly located in groove then lock together with locking ring, ensure ring is fully tightened.

Put gland cage over gland and push fully home into its appropriate body then fully tighten gland nuts.

4. To ensure a good seal, all surfaces must be completely free of dust, grease or any other contamination.

THIS CABLE CONNECTOR IS SUITABLE FOR USE WITH LOADS NOT EXCEEDING 16 AMPS USING 1.5mm² CABLE

ALWAYS USE WITH SUPPLY PROTECTED BY AN RCD (RESIDUAL CURRENT DEVICE), IF IN DOUBT CONSULT A QUALIFIED ELECTRICIAN.

DANGER

DISCONNECT MAINS
 SUPPLY BEFORE
 DISMANTLING
 CONNECTOR



- Water and dustproof to IP68 when mated
- IP68 rating tested at 1.054kg/sq cm (15lb/sq in) 10m depth for 2 weeks
- 2, 3, 4 or 6 Contact screw terminal inserts
- 3 or 8 Contact solder or crimp inserts
- 5 body styles, Flex, Inline, Panel (2 styles), Panel Side Entry
- 50Ω or 75Ω BNC (Bayonet Neill–Concelman) inserts
- 5A, 380V AC 3 & 8 way solder/crimp terminals
- 10A, 250V AC 2 & 3 way screw terminals
- 6A, 250V AC 4 way screw terminal
- 3A, 250V AC 6 way screw terminals
- EN60068-2-52 Test Kb Salt Mist (Cyclic) Marine Severity Level 1
- Plug or socket connection in each body style
- Cable range from 3.5mm - 9mm
- Diameter over coupling ring 26mm
- Positive locating keyways - cannot be mis-mated
- Sealing caps available to maintain IP68 rating of unmated connectors
- Flammability rating UL94V-0 material
- Leading earth Plug is on 3, 4 & 6 Contact screw terminal versions only
- Compact design
- Easy assembly - no special tools required on screw terminal versions
- UL approval

Flex Cable Connector Body



PX0800 - shown with insert

- PX0800 Connector body
- Mates with Inline or Panel Mounting versions
- Screw locking ring
- Suitable for Plug or Socket inserts
- Cable Acceptance 3.5-9mm (Standard 5-7mm)
- Contact inserts supplied separately

61.5 Max. Depending on Cable Dia. / Pin or Socket Carrier.

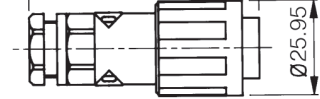

Inline Cable Connector Body



PX0801 - shown with insert

- PX0801 Connector body
- Mates with PX0800 - Flex Cable connector
- Suitable for Plug or Socket inserts
- Cable Acceptance 3.5-9mm (Standard 5-7mm)
- Contact inserts supplied separately

61.5 Max. Depending on Cable Dia. / Pin or Socket Carrier.

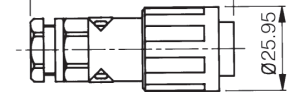

Rear Panel Mounting Body



PX0802 - shown with insert

- PX0802 Connector body
- Mates with PX0800 - Flex Cable connector
- Single hole fixing
- Suitable for Plug or Socket inserts
- Contact inserts supplied separately

37.0 Max. Depending on Pin or Socket Carrier.

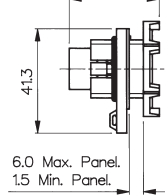

3.2^{±0.05}

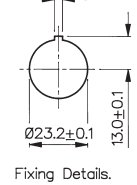

Fixing Details.

Panel Mounting Right Angle Body



PX0803 - shown with insert

- PX0803 Connector body
- Mates with PX0800 - Flex Cable connector
- Right angle cable entry
- Single hole fixing
- Suitable for Plug or Socket inserts
- Contact inserts supplied separately

53.4 Max. Depending on Panel Thickness.

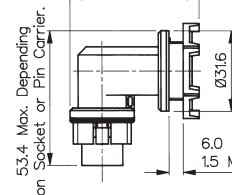

3.2^{±0.05}

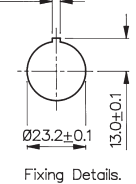

Fixing Details.

Rear Panel Mounting Body



PX0805 - shown with insert

- PX0804 and PX0805 Connector bodies
- Mates with PX0800 - Flex Cable connector
- PX0804 without sealing cap retaining clip, PX0805 with sealing cap retaining clip
- Single hole fixing
- Suitable for Plug or Socket inserts
- Contact inserts supplied separately

32.8 Max. Depending on Pin or Socket Carrier.

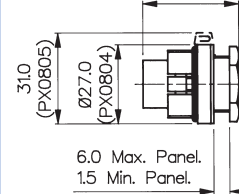

3.2^{±0.05}

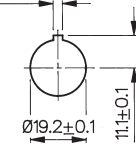

Fixing Details.

Screw Terminal Inserts



- 2, 3, 4 and 6 Contacts
- Fits all Body Styles
- Leading Earth Plug on 3, 4 and 6 Contact inserts
- Nickel Plated contacts

Screw Terminal Inserts - fits all body styles

No. Contacts	Sockets	Plugs
2	SA3319	SA3320
3	SA3229	SA3230
4	SA3242	SA3241
6	SA3244	SA3243

Contact Carrier Inserts



Inserts shown with contacts fitted

- For Solder or Crimp Contacts
- 3 or 8 Plug
- Fits all Body Styles
- Contacts Supplied Separately

Solder & Crimp Contact Carrier Inserts - fit all body styles.

No. Contacts	Solder	Colour	Crimp	Colour
3 Plug	12734/3/1	Black	12734/3	Grey
3 Socket	12735/3/1	Black	12735/3	Grey
8 Plug	12734/1	Black	12734	Grey
8 Socket	12735/1	Black	12735	Grey

Contacts, Polarising/Blanking Plugs



- Gold Plated contacts
- Solder or Crimp
- Polarising/Blanking Plugs

Contacts - Solder & Crimp - for contact carrier inserts

Contacts (Supplied in packs of 10)	Solder	Crimp
Plugs	SA3148/1	SA3148
Sockets	SA3149/1	SA3149
Polarising/Blanking Plugs	SA3147	
Contact Insertion Tool: Must be used to load contacts into inserts.	SA3150	
Crimping Tool	SA2800	

Sealing Caps



To maintain IP rating

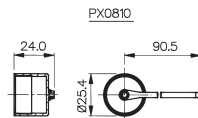

PX0810
Fits PX0801, PX0802, PX0803, PX0804 & PX0805. Ensure "O" Ring is in place on main body.

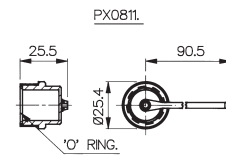

PX0811
Fits PX0800. Ensure "O" Ring is in place in cap.



Electrical	Solder/Crimp Terminals	Screw Terminals	BNC
No Contacts:	3, 8	2, 3	6
Current Rating:	5A	10A	10A 6A 3A
Voltage Rating:	380V AC	250V AC	250V AC
Contact Resistance:	<5mΩ		
Insulation Resistance:	>10 ⁹ MΩ @ 500V DC		
Voltage Proof:	2kV @ 50Hz		
Operating Temp. Range:	-20°C to +70°C		

Approvals:
 E214972

Materials	Solder/Crimp Terminals	Screw Terminals	BNC
Body Mouldings:	Polyamide UL94V-0	Polyamide UL94V-0	
Inserts:	Polyamide UL94V-0	Polyamide UL94V-0	
Contacts:	Copper Alloy, Gold Plated (0.1µm) on Nickel	Brass, Nickel Plated	Brass, Silver Plated.
O Rings:	Nitrile		
RoHS	Compliant	Compliant	Compliant

Mechanical	Solder/Crimp Terminals	Screw Terminals	BNC
Sealing:	Protection Classification IP68, EN 60529:1992+A2:2013 Tested @ 1.054kg/sq.cm. (15lb/sq.in.) 10m depth for 2 weeks.		
Salt Mist:	EN60068-2-52 Test Kb Salt Mist (Cyclic) Marine Severity Level 1		
Cable Acceptance	5-7.00mm dia - standard gland 3.5-9.00mm dia - alternative glands		
Contact Accommodation:	0.2 - 0.5mm ² (20 - 24 AWG)	1mm ² max (18 AWG)	50Ω: RG58/CU, URM43, URM76 75Ω: URM70
Insertion Force (typical):	3 way: 5N (1.1lbf) 8 way: 14N (3.1lbf)	3 way: 45N (10lbf) 4 way: 50N (11lbf) 6 way: 140N (31lbf)	
Withdrawal Force (typical):	3 way: 3N (0.66lbf) 8 way: 12N (2.6lbf)	3 way: 32N (7lbf) 4 way: 40N (9lbf) 6 way: 150N (34lbf)	
Tightening Torques			
Gland Nut, PX0800, 801:	1.13Nm (10lbf in)		
Rear Nut, PX0802, 803, 804, 805:	0.7Nm min, 1.7Nm max (6.2lbf in min, 15lbf in max)		
Sealing Cap, PX0810, 811:	0.23Nm min, 1.13Nm max (2lbf in min, 10lbf in max)		

How to order	Cable Glands
<input type="checkbox"/> Choose body type, check cable diameter and sealing gland size.	Cable gland for 5-7mm fitted as standard. BNC Insert Kit includes gland & washer to fit coax cable.
<input type="checkbox"/> Determine contact carrier inserts. Choose number of Contacts, and type of contacts (solder, crimp, screw terminal or BNC).	
<input type="checkbox"/> Choose Plugs or sockets. Solder and crimp contacts are supplied separately in packs of ten.	
<input type="checkbox"/> Choose polarising/blanking Plugs. If required for solder/crimp contact inserts. Supplied in packs of ten.	
<input type="checkbox"/> Is an insertion tool required (for solder or crimp contacts)?	
<input type="checkbox"/> Is a crimp tool required?	
<input type="checkbox"/> Is a sealing cap required?	

Cable Diameter	Gland Part No.	Gland Colour	Additional Suffix
5-7mm	12023/1	White	Fitted as standard
3.5-5mm	SA3426	Grey	Suffix /04†
6-8mm	12023	Black	Suffix /06
7-9mm	12023/2	Yellow	Suffix /07
Gland Pack	PX0812		Pack of 3 glands to suit cables 3.5-5mm, 6-8mm, 7-9mm dia†

To order body with alternative cable gland add suffix to part no. e.g. PX0800/06 = PX0800 body with cable gland to suit 6-8mm dia. cable.
 †Includes additional black gland cage for 3.5-5mm dia. cable range.

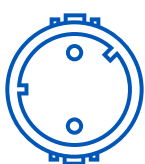

2 Contact
(10 Amp)



3 Contact
(10 Amp)



4 Contact
(6 Amp)



6 Contact
(3 Amp)



8 Contact
(5 Amp)



- IP68 rating tested at 1.054kg/sq cm (15lb/sq in) 10m depth for 2 weeks
- IP69K, Tested in accordance with DIN 40050/Part 9 IP6k9k
- 2 and 3 Contact - 8A, 250V rating
- 4, 6 and 8 Contact - 5A, 125V rating
- 10 and 12 Contact - 1A, 50V rating
- 2.5mm contact engagement for electrical integrity 'Scoop proof' contacts
- Contact inserts are part of body moulding
- Cable range from 3 to 7mm
- Overall length (flex + Inline) 80mm
- Gold plated contacts
- Diameter over coupling ring 19.1mm
- Pre-wired, overmoulded cable assemblies
- Flex, Inline, Front Panel, Rear Panel and PCB mounting body styles
- Plug and Socket versions in all body styles
- Flame Retardant moulding material - Polyamide UL94-V0
- Contacts supplied separately (except PCB versions)
- Sealing caps available to maintain IP68 rating
- Secure sealing system
- Crimp and solder contacts
- PCB mounting connector supplied with contacts pre-loaded
- Front and rear panel mounting panel connectors
- VDE and cULus approvals
- EN60068-2-52 Test Kb Salt Mist (Cyclic) Marine Severity Level 1
- Smart options available with EEPROM memory chip

Flex Cable Connector



PX0410

- Mates with Inline or Panel mounting versions PX0401, PX0411, PX0412 & PX0413
- Plug or socket
- 2, 3, 4, 6, 8, 10 or 12 Contact
- Screw locking ring
- Contacts supplied separately

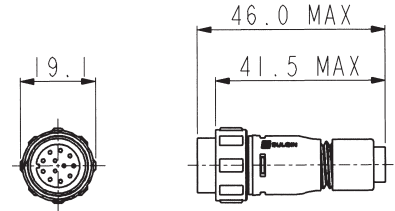

Inline Cable Connector



PX0411

- Mates with Flex Cable connectors PX0400, PX0402 & PX0410
- Plug or socket
- 2, 3, 4, 6, 8, 10 or 12 Contact
- For Inline cable connection
- Contacts supplied separately

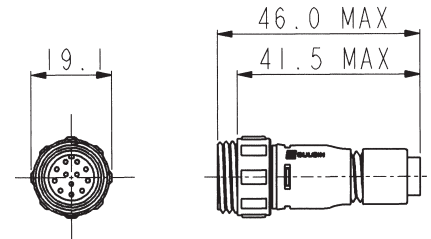

Pre Wired Flex Cable Connector



PX0400

- Overmoulded Flex connector for pre-wired cable assemblies
- Plug or socket
- Cable range 2.5 -9.0mm O/D
- 2, 3, 4, 6, 8, 10 or 12 Contact
- Mates with PX0401 & PX0411 Inline connectors and PX0412 & PX0413 panel mounting connectors

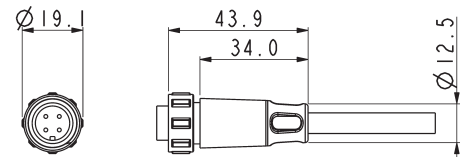

Pre Wired Flex Cable Connector



PX0402

- Right-angled overmoulded Flex connector for pre-wired cable assemblies
- Plug or socket
- Cable range 2.5 -9.0mm O/D
- 2, 3, 4, 6, 8, 10 or 12 Contact
- Mates with PX0401 & PX0411 Inline connectors and PX0412 & PX0413 panel mounting connectors

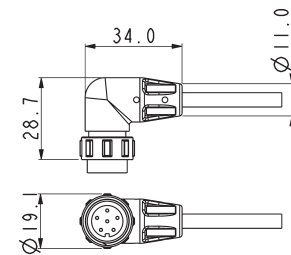

Smart Connector



PXS410

- Overmoulded pre-wired sealed connector
- 4, 6, 8, 10, 12 Contact
- Embedded memory chip through 1 wire EEPROM
- Mates with PX0401 & PX0411 Inline connectors and PX0412 & PX0413 panel mounting connectors

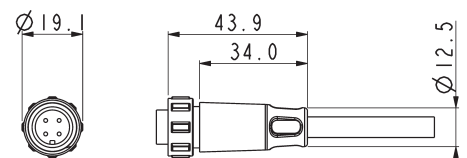

Front Panel Mounting Connector



PX0412

- Mates with Flex Cable connectors PX0410, PX0400 & PX0402
- Single hole fixing
- Contacts supplied separately
- 2, 3, 4, 6, 8, 10 or 12 Contact

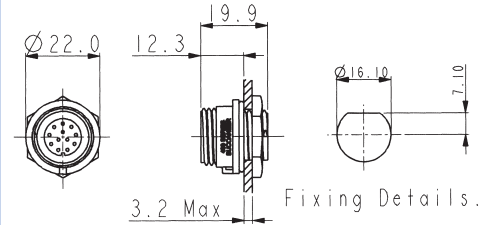

Rear Panel Mounting Connector



PX0413/XXX

- Mates with Flex Cable connector PX0410, PX0400 & PX0402
- Single hole fixing
- Contacts supplied separately
- 2, 3, 4, 6, 8, 10 or 12 Contact

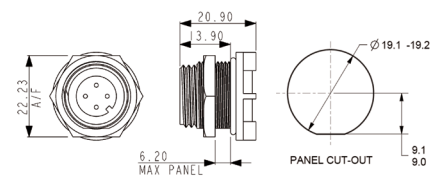

PCB Mounting Connector



PX0413/XXX/PC

- Mates with Flex Cable connector PX0410, PX0400 & PX0402
- PCB Rear Panel mounting
- Straight PC spills
- Supplied with pre-loaded gold plated contacts
- 2, 3, 4, 6, 8, 10 or 12 Contact

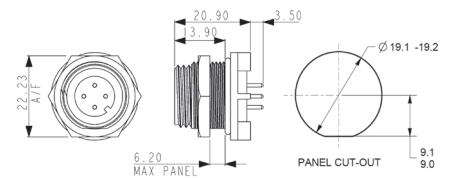

Sealing Caps



PX0480 PX0480/1 PX0481 PX0484

- Maintains IP68 Rating of Unmated Connectors
- PX0480: Fits PX0412 (panel mounting)
- PX0480/1: Fits PX0401 & PX0411 (Inline)
- PX0481: Fits PX0400, PX0402 & PX0410 (flex connector)
- PX0484: Fits PX0413 (PCB and rear panel mount)

Gland Packs

Part No	Description
PX0482	Pack of 4 pairs cable glands and collets to suit cables from 3.0 to 5.0mm diameter.
PX0483	Pack of 4 pairs cable glands and collets to suit cables from 5.0 to 7.0mm diameter.

Crimp Contacts

Contact	Current Rating	Plug Part No.	Socket Part No.	Pack Qty	Cable Acceptance (dia)
2, 3	8A	SA3350	SA3349	10	20 - 24 AWG
4, 6, 8	5A	SA3348	SA3347	10	22 - 26 AWG
10, 12	1A	SA3180	SA3179	10	24 - 28 AWG

Solder Contacts

Contact	Current Rating	Plug Part No.	Socket Part No.	Pack Qty	Cable Acceptance (dia)
2, 3	8A	SA3350/1	SA3349/1	10	20 - 24 AWG
4, 6, 8	5A	SA3348/1	SA3347/1	10	22 - 26 AWG
10, 12	1A	SA3180/1	SA3179/1	10	24 - 28 AWG

Insertion / Extraction

	Contacts	Contact Rating	Colour	Part No
Insertion/Extraction Tool	2,3	8A	Blue	13027/2
Insertion/Extraction Tool	4,6,8	5A	Red	13027/1
Insertion/Extraction Tool	10,12	1A	Green	13027

Crimp tools

	Contacts	Contact Rating	Colour	Part No
Positioner	2,3	8A	Blue	14025/8AMP
Positioner	4,6,8	5A	Red	14025/5AMP
Positioner	10,12	1A	Green	14025/1AMP
8 Indent Crimp Tool for use with positioners				14025

PX0413 PCB Contact Layout

Sockets

Contact numbers viewed from rear of panel

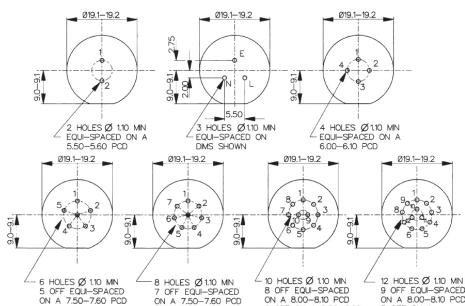

Plugs

Contact numbers viewed from rear of panel

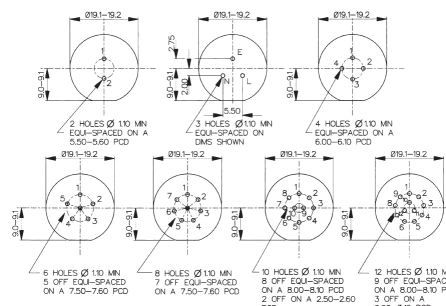

2 Contact
(8 Amp)



3 Contact
(8 Amp)



4 Contact
(5 Amp)



6 Contact
(5 Amp)



8 Contact
(5 Amp)



10 Contact
(1 Amp)



12 Contact
(1 Amp)



Electrical:

No. Contacts:	2, 3	4, 6, 8	10, 12
Current Rating:	8A	5A	1A
Voltage Rating:	250V AC/DC	125V AC/DC	50V AC/DC
Contact Resistance:	<5mΩ		
Insulation Resistance:	>10 ⁶ MΩ (@ 500V DC)		
AC Breakdown voltage:	2.5kV		
Cycles:	>1000		
Operating Temperature:			
Flex and panel types	-40°C to +80°C		
Overmoulded	-20°C to +60°C		

Approvals:

cULus (Underwriters Laboratory)	E214972
VDE (Verband der Elektrotechnik)	40002226

Overmoulded cable assemblies approvals to customer requirements.

Material:

Flex and panel types:	
Body Mouldings:	Polyamide
Flammability Rating:	UL94V-0
UV Resistance:	To EN 50021:1999
Overmoulded types:	
Body Mouldings:	Polyurethane
Flammability Rating:	UL94V-HB
Contacts:	Copper alloy, Gold plated
O Rings:	Nitrile
Panel Sealing O Ring:	Nitrile
RoHS	Compliant

Smart Connector EEPROM:

1024 - Bit Memory
1 - Wire
Can be Write Protected
Manufacturer - Maxim Intergrated
Part Number - 0S2431

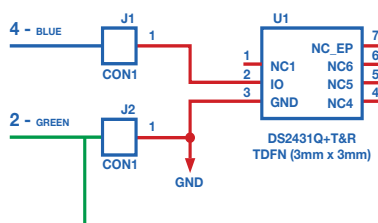

Mechanical:

Sealing:	IP69K, Tested in accordance with DIN 40050/Part 9 IP6k9k
	IP68, EN60529:1992+A2:2013 tested @ 1.054kg/sq cm (15lb/sq in) 10m depth for 2 weeks
Salt Mist:	EN60068-2-52 Test Kb Salt Mist (Cyclic) Marine Severity Level 1
Cable Acceptance:	3.0 - 7.0mm
Contact Accommodation:	2, 3 Contact, 20 - 24 AWG 4, 6, 8 Contact, 22 - 26 AWG 10, 12 Contact, 24 - 28 AWG
Termination:	Crimp, solder and PCB
Insertion/Withdrawal Force:	
No. Contacts:	2 3 4 6 8 10 12
Insertion Force (typ):	19N 25N 27N 27N 28N 55N 62N
Withdrawal Force (typ):	12N 17N 17N 21N 22N 25N 29N
Tightening Torques:	
Panel mount (PX0412)	
Rear fixing nut:	1.0-1.1Nm (9lbf.in.)
Panel mount (PX0413)	
Front fixing nut:	1.0-1.1Nm (9lbf.in.)
Cable Retention force:	
3.0mm dia	60N
4.0 to 7.0mm dia	80N
Rear panel thread PX0412:	M16x1.5
Panel thread PX0413:	18.97x26TPI Whitworth form to BS84 med fit

Dimensions:

Overall dimensions of connectors when mated together	
Flex + Inline	80mm
Dia. over coupling ring	19.1mm
	Dia. over coupling ring

Plug	Wire Colour
1	Red
2	Green
3	Yellow
4	Blue
5	White
6	Black
7	Brown
8	Violet
9	Orange
10	Pink
11	Turquoise
12	Grey

Standard:

PX041X	/	XX	X	/	XXXX
Body Styles PX0410 = Flex body PX0411 = Inline body PX0412 = Front panel mounting body PX0413 = Rear panel/PCB mounting body		Number of Contacts 02 03 04 06 08 10 12	Contact Type P = Plug, S = Socket		For PX0410 and PX0411 cable connectors - Cable Entry Size: 3035 = 3.0 - 3.5mm (Light Grey) 3540 = 3.5 - 4.0mm (Grey) 4045 = 4.0 - 4.5mm (Green) 4550 = 4.5 - 5.0mm (Red) 5055 = 5.0 - 5.5mm (Yellow) 5560 = 5.5 - 6.0mm (Blue) 6065 = 6.0 - 6.5mm (White) 6570 = 6.5 - 7.0mm (Black)
Examples: PX0410/10S/4045 = Flex cable connector, 10 socket contacts with gland and collet for cables between 4.0 and 4.5mm diameter (supplied less contacts). PX0412/08P = Front panel mounting connector, 8 Plug contacts (supplied less contacts). PX0413/06P = Rear panel mounting connector, for 6 Plug contacts (supplied less contacts). PX0413/04P/PC = Rear panel/PCB connector, 4 Plug contacts, PCB mounting (supplied with contacts loaded).					Cable gland and collet supplied in colour coded pairs. For PX0413 PCB/Rear Panel Mount: PC = Pre-loaded PC Plugs Blank = no Plugs supplied For PX0412 Front Panel Mount: Suffix not required - leave blank

Pre Wired Variation:

PX040X	/	XXX	/	XX	/	X
Body Styles PX0400 = Pre Wired Flex Cable Connector PX0402 = Pre Wired Flex Cable Connector - Right angle		Length 001 = 1m 002 = 2m 003 = 3m ... 015 = 15m		Number of Contacts 02 03 04 06 08 12		Contact Type P = Plug S = Socket

Smart:

PXS410	/	XX	/	XX	/	X
Body Styles PXS410 = Flex body		Cable length 02 = 2m 03 = 3m 05 = 5m 10 = 10m		Number of Contacts 04 06 08 10 12		Contact Type P = Plug S = Socket

Examples:

PXS410/02/04/P = Smart flex cable connector, 2m cable to free end, 4 Plug contact



- Sealed to IP68 when mated
- IP68 rating tested at 1.054kg/sq cm (15lb/sq in) 10m depth for 2 weeks
- 2, 3, 4, 6, 8, 10 & 12 Contact configuration
- Power ratings up to 13A, 600V
- Cable range from 3 to 7mm
- Diameter over coupling ring 19.8mm
- Flex, Inline, Rear Panel and PCB mounting body styles
- Colour coded O-rings & washers for easy identification purposes
- Plug and Socket versions in all body styles
- Flame Retardant moulding material - Polybutylene Terephthalate/Polycarbonate (PBT/PC) UL94-V0
- Contacts supplied separately (except PCB versions)
- Sealing caps available to maintain IP68 rating
- Crimp and solder contacts
- cULus and VDE approvals
- EN60068-2-64 Vibration Resistance

Flex Cable Connector



PXP4010

- Mates with Inline or Panel mounting versions PXP4011, PXP4013
- Plug or socket
- 2, 3, 4, 6, 8, 10 & 12 Contacts
- ¼ turn locking ring
- Contacts supplied separately

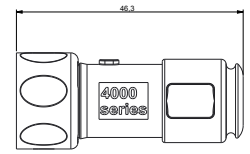
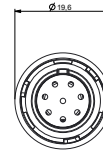

Inline Cable Connector



PXP4011

- Mates with Flex Cable connector PXP4010
- Plug or socket
- 2, 3, 4, 6, 8, 10 & 12 Contacts
- For Inline cable connection
- Contacts supplied separately

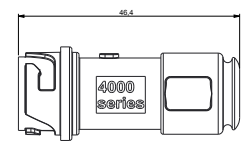

Rear Panel Mounting Connector
(locking nut included)



PXP4013

- Mates with Flex Cable connector PXP4010
- Plug or socket
- Single hole fixing
- Contacts supplied separately
- 2, 3, 4, 6, 8, 10 & 12 Contacts

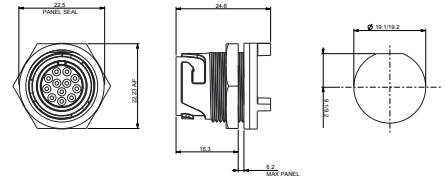

PCB Mounting Connector
(locking nut included)



PXP4013/XXX/PC

- Mates with Flex Cable connector PXP4010
- Plug or socket
- PCB Rear Panel mounting
- Straight PC spills
- Supplied with pre-loaded gold plated contacts
- 2, 3, 4, 6, 8, 10 & 12 Contacts

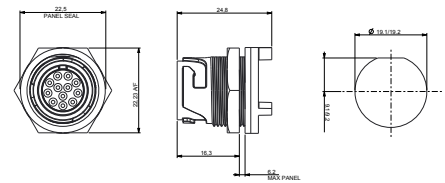

Sealing Caps



PXP4081 PXP4082 PXP4083

- Maintains IP68 sealed rating of unmated connectors

Part no.	Description
PXP4081	Sealing cap for use with PXP4010 & PXP4040
PXP4082	Sealing cap for use with PXP4011
PXP4083	Sealing cap for use with PXP4013 & PXP4043

Gland Packs



Part no.	Description
PXP4088/0305	Pack of 4 pairs cable glands and collets to suit cables from 3.0 to 5.0mm diameter.
PXP4088/0507	Pack of 4 pairs cable glands and collets to suit cables from 5.0 to 7.0mm diameter.

O-ring & washer pack



Part no.	Description
PXP4089/YL	Yellow coloured O-ring and washer pack
PXP4089/BL	Blue coloured O-ring and washer pack
PXP4089/RD	Red coloured O-ring and washer pack
PXP4089/WH	White coloured O-ring and washer pack
PXP4089/GN	Green coloured O-ring and washer pack

Crimp Contacts

Contacts	Current Rating	Plug Part No.	Socket Part No.	Pack Qty	Cable Acceptance (dia)
2, 3	13A /*10A	SA3350	SA3349	10	16 - 18 AWG
4, 6, 8	8A /*5A	SA3348	SA3347	10	18 - 20 AWG
10, 12	3A /*3A	SA3180	SA3179	10	22 - 24 AWG

Solder Contacts

Contacts	Current Rating	Plug Part No.	Socket Part No.	Pack Qty	Cable Acceptance (dia)
2,3	13A /*10A	SA3350/1	SA3349/1	10	16 - 18 AWG
4, 6, 8	8A /*5A	SA3348/1	SA3347/1	10	18 - 20 AWG
10, 12	3A /*3A	SA3180/1	SA3179/1	10	22 - 24 AWG

Insertion / Extraction

	Contacts	Contact Rating	Colour	Part No
Insertion/Extraction Tool	2, 3	13A /*10A	Blue	13027/2
Insertion/Extraction Tool	4, 6, 8	8A /*5A	Red	13027/1
Insertion/Extraction Tool	10, 12	3A /*3A	Green	13027

Crimp tools

	Contacts	Contact Rating	Colour	Part No
Positioner	2, 3	13A /*10A	Orange	14025/1618
Positioner	4, 6, 8	8A /*5A	Grey	14025/1820
Positioner	10, 12	3A /*3A	Yellow	14025/2224
8 Indent Crimp Tool for use with positioners				14025

*Current rating for CSA standards

PXP4013 PCB Contact Layout

Sockets

Contact numbers viewed from rear of panel

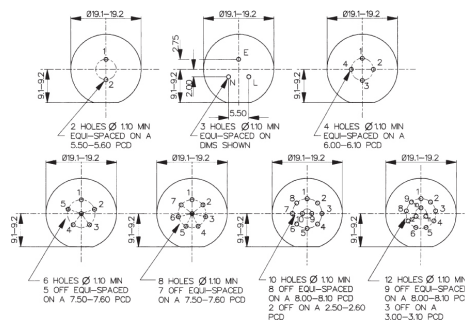

Plugs

Contact numbers viewed from rear of panel

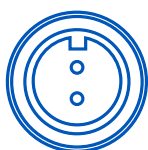
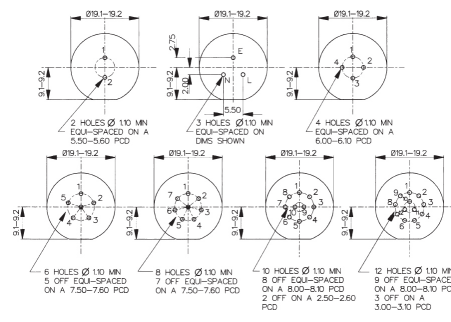

2 Contacts
(13 Amp)

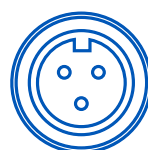

3 Contacts
(13 Amp)

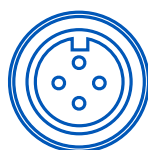

4 Contacts
(8 Amp)



6 Contacts
(8 Amp)



8 Contacts
(8 Amp)



10 Contacts
(3 Amp)



12 Contacts
(3 Amp)

BUCCANEER FOR POWER
4000 Series Buccaneer

Specifications



Electrical:

No. Contacts:	2 & 3	4, 6 & 8	10 & 12
Current Rating UL / VDE:	13A	8A	3A
Current Rating CSA:	10A	5A	3A
Voltage Rating:	600V AC/DC	320V AC/DC	160V AC/DC
Contact Resistance:	<5mΩ		
Insulation Resistance:	>10 ⁶ MΩ (@ 500V DC)		
AC Breakdown voltage:	2.5kV		
Cycles:	>1000		
Operating Temperature:			
Flex and panel types	-40°C to +120°C		

Approvals:

- UL (Underwriters Laboratory) (including cUL)
- VDE (Verband der Elektrotechnik)

Material:

Flex and panel types:	
Body Mouldings:	Polybutylene Terephthalate/ Polycarbonate (PBT/PC)
Flammability Rating:	UL94V-0
UV Resistance:	To EN 50021:1999
Contacts:	Copper alloy, Gold plated
O Rings:	Silicone
Panel Sealing O Ring:	Silicone
RoHS	Compliant

Mechanical:

Sealing:	IP68 to En60529:1992+A2:2013 (10m depth for 2 weeks)
Vibration:	BS EN 60068-2-64:2008 Test Fh BS EN 60068-2-27:2009 Test Ea
Cable Acceptance:	3.0 - 7.0mm
Contact Accommodation:	2 & 3 Contacts, 16 - 18 AWG 4, 6 & 8 Contacts, *18 - 20 AWG 10 & 12 Contacts, 22 - 24 AWG *Solid Core Wire Only
Termination:	Crimp, solder and PCB
Insertion/Withdrawal Force:	
No. Contacts:	2 & 3 4, 6, 8 10 & 12
Insertion Force (typ):	25N 28N 32N
Withdrawal Force (typ):	12N 15N 18N

Panel mount (PXP4013)	
Front fixing nut:	1.0-1.1Nm (9lbf.in.)
Cable Retention force:	60N 80N
3.0mm dia	
4.0 to 7.0mm dia	
Panel thread PXP4013:	18.97x26TPI Whitworth form to BS84 med fit

Dimensions:

Overall dimensions of connectors when mated together	
Flex + Inline	80mm
Dia. over coupling ring	19.7mm

PXP40XX	/	XX	X	/	XXXX
<p>Body Styles</p> <p>PXP4010 = Flex PXP4011 = Inline PXP4013 = Rear panel/PCB mounting</p>		<p>Number of Contacts</p> <p>02 03 04 06 08 10 12</p>	<p>Contact Type</p> <p>P = Plug, S = Socket</p>		<p>For PXP4010 and PXP4011 cable connectors - Cable Entry Size:</p> <p>3035 = 3.0 - 3.5mm (Light Grey) 3540 = 3.5 - 4.0mm (Grey) 4045 = 4.0 - 4.5mm (Green) 4550 = 4.5 - 5.0mm (Red)</p> <p>5055 = 5.0 - 5.5mm (Yellow) 5560 = 5.5 - 6.0mm (Blue) 6065 = 6.0 - 6.5mm (White) 6570 = 6.5 - 7.0mm (Black)</p> <p>Cable gland and collet supplied in colour coded pairs.</p> <p>For PXP4013 PCB/Rear Panel Mount: PC = Pre-loaded PC Plugs Blank = no Plugs supplied</p>
<p>Examples:</p> <p>PXP4010/03S/4045 = Flex cable connector, 3 socket contacts with gland and collet for cables between 4.0 and 4.5mm diameter (supplied less contacts). PXP4013/08P = Rear panel mounting connector, for 8 Plug contacts (supplied less contacts). PXP4013/03P/PC = Rear panel/PCB connector, 3 Plug contacts, PCB mounting (supplied with contacts loaded).</p>					

6000 Series Buccaneer – **circular connectors** that combine the ease of use of a **push/pull coupling mechanism** with proven environmental sealing. Available with **metal** or **plastic** bodies, the range supports both data (USB and Ethernet), signal and mains power. Designed and independently tested to **IP66, IP68 & IP69K** standards, they are ideal for applications where ingress of dust and water must be avoided and where ease of connection, space and appearance are important considerations.

- **Secure, quick connector mating and release**
- **30° twist locking**
Tamperproof lock prevents accidental un-mating
- **IP66, IP68 and IP69K when mated**
Suitable for a wide range of dust and water borne environments
- **All plastic body version; UL94-V0 rated, UV stable, halogen free**
Light-weight, self-extinguishing material suitable for long-term outdoor use
- **Flex, Inline & panel mount body styles, with sealing caps**
Complete family of products maintain sealing integrity in all styles
- **Polarisation and visual alignment features**
Aids the correct mating of connectors
- **2 to 22 Contacts – up to 16A, 277V rated**
Suitable for mains power to signal applications
- **'Scoop proof' contacts**
Prevents damage through mis-mating – ideal for 'blind mating' applications
- **cULus, UL, VDE**
Internationally recognised certification
- **Screw, Crimp and Solder terminations available**



BUCCANEER FOR POWER
6000 Series Buccaneer

Thermo Plastic



Flex Cable Connector



PXP6010

- Mates with Inline or Panel Mounting versions PXP6011 & PXP6012
- Push/pull locking ring with 30° twist locking
- Plug or socket versions
- Leading earth on 3 Contact connectors
- 2, 3, 4, 8, 16 & 22 Contact
- Screw, solder and crimp termination

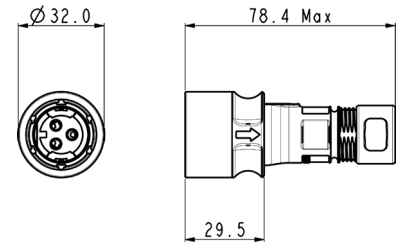

Contacts	Termination	Plug Contacts	Socket Contacts	Contacts
2	Screw	PXP6010/02P/ST	PXP6010/02S/ST	Supplied Fitted
2	Crimp / Solder	PXP6010/02P/CR	PXP6010/02S/CR	Contacts Required
3	Screw	PXP6010/03P/ST	PXP6010/03S/ST	Supplied Fitted
3	Crimp / Solder	PXP6010/03P/CR	PXP6010/03S/CR	Contacts Required
4	Crimp / Solder	PXP6010/04P/CR	PXP6010/04S/CR	Contacts Required
8	Crimp / Solder	PXP6010/08P/CR	PXP6010/08S/CR	Contacts Required
16	Crimp / Solder	PXP6010/16P/CR	PXP6010/16S/CR	Contacts Required
22	Crimp / Solder	PXP6010/22P/CR	PXP6010/22S/CR	Contacts Required

Inline Cable Connector



PXP6011

- Mates with Flex Cable connector PXP6010
- For Inline cable connection
- Plug or socket versions
- Leading earth on 3 Contact connectors
- 2, 3, 4, 8, 16 and 22 Contact
- Screw, solder and crimp termination

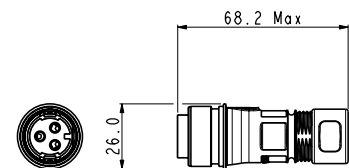

Contacts	Termination	Plug Contacts	Socket Contacts	Contacts
2	Screw	PXP6011/02P/ST	PXP6011/02S/ST	Supplied Fitted
2	Crimp / Solder	PXP6011/02P/CR	PXP6011/02S/CR	Contacts Required
3	Screw	PXP6011/03P/ST	PXP6011/03S/ST	Supplied Fitted
3	Crimp / Solder	PXP6011/03P/CR	PXP6011/03S/CR	Contacts Required
4	Crimp / Solder	PXP6011/04P/CR	PXP6011/04S/CR	Contacts Required
8	Crimp / Solder	PXP6011/08P/CR	PXP6011/08S/CR	Contacts Required
16	Crimp / Solder	PXP6011/16P/CR	PXP6011/16S/CR	Contacts Required
22	Crimp / Solder	PXP6011/22P/CR	PXP6011/22S/CR	Contacts Required

Front Panel Mounting Connector



PXP6012

- Mates with Flex Cable connectors PXP6010
- Front panel mounting
- Single hole fixing
- Plug or socket versions
- Leading earth on 3 Contact connectors
- 2, 3, 4, 8, 16 and 22 Contact
- Screw, solder and crimp termination

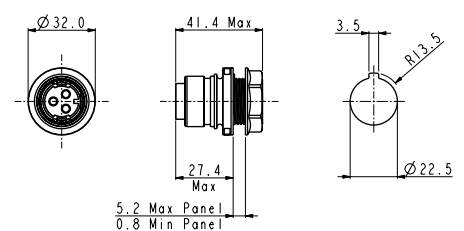

Contacts	Termination	Plug Contacts	Socket Contacts	Contacts
2	Screw	PXP6012/02P/ST	PXP6012/02S/ST	Supplied Fitted
2	Crimp / Solder	PXP6012/02P/CR	PXP6012/02S/CR	Contacts Required
3	Screw	PXP6012/03P/ST	PXP6012/03S/ST	Supplied Fitted
3	Crimp / Solder	PXP6012/03P/CR	PXP6012/03S/CR	Contacts Required
4	Crimp / Solder	PXP6012/04P/CR	PXP6012/04S/CR	Contacts Required
8	Crimp / Solder	PXP6012/08P/CR	PXP6012/08S/CR	Contacts Required
16	Crimp / Solder	PXP6012/16P/CR	PXP6012/16S/CR	Contacts Required
22	Crimp / Solder	PXP6012/22P/CR	PXP6012/22S/CR	Contacts Required

BUCCANEER FOR POWER
6000 Series Buccaneer

Thermo Plastic



Screwed Front Panel Mounting Connector



PXP6014

- Mates with Flex Cable connectors PXP6010
- Front panel mounting
- M24x1.5 thread to engage the connector to the panel
- Plug or socket versions
- Leading earth on 3 Contact connectors
- 2, 3, 4, 8, 16 and 22 Contact
- Screw, solder and crimp termination

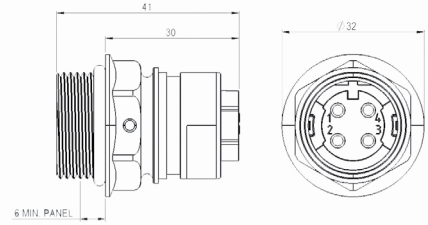

Contacts	Termination	Plug Contacts	Socket Contacts	Contacts
2	Screw	PXP6014/02P/ST	PXP6014/02S/ST	Supplied Fitted
2	Crimp / Solder	PXP6014/02P/CR	PXP6014/02S/CR	Contacts Required
3	Screw	PXP6014/03P/ST	PXP6014/03S/ST	Supplied Fitted
3	Crimp / Solder	PXP6014/03P/CR	PXP6014/03S/CR	Contacts Required
4	Crimp / Solder	PXP6014/04P/CR	PXP6014/04S/CR	Contacts Required
8	Crimp / Solder	PXP6014/08P/CR	PXP6014/08S/CR	Contacts Required
16	Crimp / Solder	PXP6014/16P/CR	PXP6014/16S/CR	Contacts Required
22	Crimp / Solder	PXP6014/22P/CR	PXP6014/22S/CR	Contacts Required

Flex Cable Connector



PXM6010

- Mates with Inline or Panel Mounting versions PXM6011 and PXM6012
- Push/pull locking ring with 30° twist locking
- Plug or socket versions
- Leading earth on 3 Contact connectors
- 2, 3, 4, 8, 16 and 22 Contact
- Screw, solder and crimp termination
- Cable braid termination accessory option, add /SNsuffix

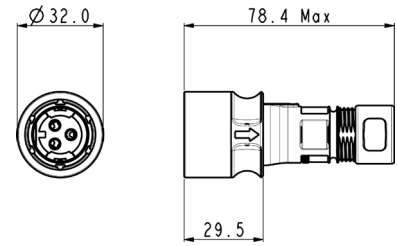

Contacts	Termination	Plug Contacts	Socket Contacts	Contacts
2	Screw	PXM6010/02P/ST	PXM6010/02S/ST	Supplied Fitted
2	Crimp / Solder	PXM6010/02P/CR	PXM6010/02S/CR	Contacts Required
3	Screw	PXM6010/03P/ST	PXM6010/03S/ST	Supplied Fitted
3	Crimp / Solder	PXM6010/03P/CR	PXM6010/03S/CR	Contacts Required
4	Crimp / Solder	PXM6010/04P/CR	PXM6010/04S/CR	Contacts Required
8	Crimp / Solder	PXM6010/08P/CR	PXM6010/08S/CR	Contacts Required
16	Crimp / Solder	PXM6010/16P/CR	PXM6010/16S/CR	Contacts Required
22	Crimp / Solder	PXM6010/22P/CR	PXM6010/22S/CR	Contacts Required

Inline Cable Connector



PXM6011

- Mates with Flex Cable connector PXM6010
- For Inline cable connection
- Plug or socket versions
- Leading earth on 3 Contact connectors
- 2, 3, 4, 8, 16 and 22 Contact
- Screw, solder and crimp termination
- Cable braid termination accessory option, add /SNsuffix

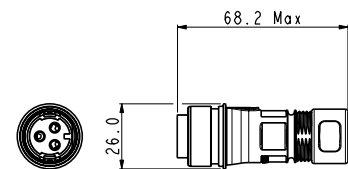

Contacts	Termination	Plug Contacts	Socket Contacts	Contacts
2	Screw	PXM6011/02P/ST	PXM6011/02S/ST	Supplied Fitted
2	Crimp / Solder	PXM6011/02P/CR	PXM6011/02S/CR	Contacts Required
3	Screw	PXM6011/03P/ST	PXM6011/03S/ST	Supplied Fitted
3	Crimp / Solder	PXM6011/03P/CR	PXM6011/03S/CR	Contacts Required
4	Crimp / Solder	PXM6011/04P/CR	PXM6011/04S/CR	Contacts Required
8	Crimp / Solder	PXM6011/08P/CR	PXM6011/08S/CR	Contacts Required
16	Crimp / Solder	PXM6011/16P/CR	PXM6011/16S/CR	Contacts Required
22	Crimp / Solder	PXM6011/22P/CR	PXM6011/22S/CR	Contacts Required

Front Panel Mounting Connector



PXM6012

- Mates with Flex Cable connectors PXM6010
- Single hole fixing
- Plug or socket versions
- Leading earth on 3 Contact connectors
- 2, 3, 4, 8, 16 and 22 Contact
- Screw, solder and crimp termination

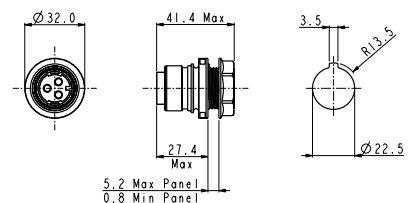

Contacts	Termination	Plug Contacts	Socket Contacts	Contacts
2	Screw	PXM6012/02P/ST	PXM6012/02S/ST	Supplied Fitted
2	Crimp / Solder	PXM6012/02P/CR	PXM6012/02S/CR	Contacts Required
3	Screw	PXM6012/03P/ST	PXM6012/03S/ST	Supplied Fitted
3	Crimp / Solder	PXM6012/03P/CR	PXM6012/03S/CR	Contacts Required
4	Crimp / Solder	PXM6012/04P/CR	PXM6012/04S/CR	Contacts Required
8	Crimp / Solder	PXM6012/08P/CR	PXM6012/08S/CR	Contacts Required
16	Crimp / Solder	PXM6012/16P/CR	PXM6012/16S/CR	Contacts Required
22	Crimp / Solder	PXM6012/22P/CR	PXM6012/22S/CR	Contacts Required

Crimp / Solder Contacts			Contacts (for 2 & 3 Contact) (Supplied in packs of 10)	Crimp	Solder
 <p>2, 3, 4, 8, 16 & 22 Contact contacts</p>	<ul style="list-style-type: none"> ○ Gold Plated ○ Current ratings: 2 & 3 Contact : 16A 4 & 8 Contact : 10A 16 Contact : 3A 22 Contact : 2A 	Plugs	SA3545/P	SA3624/P	
		Sockets	SA3545/S	SA3624/S	
		Contacts (for 4 & 8 Contact) (Supplied in packs of 10)		Crimp	Solder
		Plugs	SA3544/P	SA3623/P	
		Sockets	SA3544/S	SA3623/S	
		Contacts (for 16 & 22 Contact) (Supplied in packs of 10)		Crimp	Solder
		Plugs	SA3542/P	SA3622/P	
		Sockets	SA3542/S	SA3622/S	

Crimp Tooling			Crimp Tooling	
 <p>PNo 14232</p>	<ul style="list-style-type: none"> ○ Crimp Tools for 2, 3, 4, 8, 16 and 22 Contact crimp contacts 	Crimp Tool (2 & 3 Contact)	PNo.14232	
		Positioner (2 & 3 Contact)	PNo.14232/2/SP	
		Crimp Tool (4, 8, 16 & 22 Contact)	PNo.14025	
		Positioner (4 & 8 Contact)	PNo.15021/SP	
		Positioner (16 & 22 Contact)	PNo.15019/SP	

Extraction Tool			Extraction Tools	
	<ul style="list-style-type: none"> ○ Extraction Tool for 2, 3, 4, 8, 16 and 22 Contact contacts 	Extraction Tool (2 & 3 Contact)	PNo.14946/SP	
		Extraction Tool (4 & 8 Contact)	PNo.14945/SP	
		Extraction Tool (16 & 22 Contact)	PNo.14944/SP	

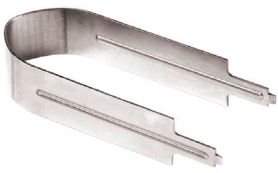
Contact Carrier Removal Tool			Tools	
 <p>PNo 14917</p>	<ul style="list-style-type: none"> ○ For removal of all contact carriers 	Contact carrier removal tool (all Contacts)	PNo. 14917/SP	

Sealing Caps



PXM6083 PXM6082 PXM6081

- Maintains IP Rating of Unmated Connectors
- PXM6081: Fits PXM6010 (Flex Connector)
- PXM6082: Fits PXM6011 (Inline Connector)
- PXM6083: Fits PXM6012 (Panel Connector)

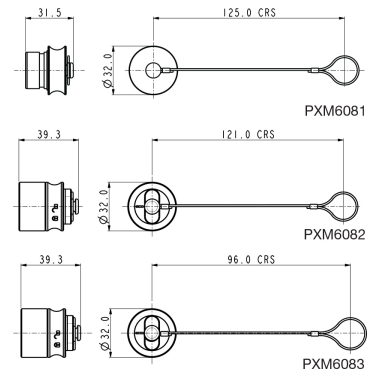

Plastic Sealing Caps



PXP6083 PXP6082 PXP6081

- Maintains IP Rating of Unmated Connectors
- PXP6081: Fits PXP6010 (Flex Connector)
- PXP6082: Fits PXP6011 (Inline Connector)
- PXP6083: Fits PXP6012 & PXP6014 (Panel Connector)

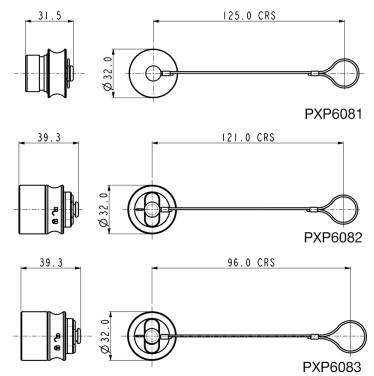

Cable Gland Pack



PXP6088

- Pack of all cable glands to suit cable ranges from 4.0 to 10.0mm diameter
- Light Grey: 9-10mm
- Yellow: 7-9mm
- White: 5-7mm
- Dark Grey: 4-5mm

Cable Braid Termination Option



PXM6090

- For cable braid termination
- Supplied with ty-rap





PXX	601X	/ XX	X	/ XX	/ XXXX	/ XX
Series Designation	Series / Body Style	No. of Contacts	Contacts Type	Terminations	Cable Entry Size	Cable Braid Termination Accessory
PXM= Metal Series PXP= Plastic Series	6010 = Flex 6011 = Inline 6012 = Front Panel 6014 = Screwed Front Panel (Plastic Only)	02 03 04 08 16 22	P = Plug S = Socket	CR = Contacts Required ST = Screw (2 and 3 Contact only)	(for Flex and Inline connectors only) 0405 = 4-5mm (Dark Grey) 0507 = 5-7mm (White) 0709 = 7-9mm (Yellow) 0910 = 9-10mm (Light Grey)	(for Metal Flex and Inline connectors only) SN if required Blank if not required

Examples

PXM6010/03P/CR/0507= Flex cable connector, 3 Contact, Plug contacts with 5 to 7mm cable glands
 PXM6012/03/S/ST= Front panel mounting connector, 3 Contact, socket with screw termination

Electrical:

No. Contacts:	2	3	4	8	16	22
Current Rating: See de-rating curves for further information						
VDE	16A	16A	10A	10A	3A	2A
UL	16A	16A	7A	7A	3A	3A
cUL	11A	11A	4A	4A	1.5A	1.5A
Voltage	277V	277V	277V	277V	60V	60V
Rated cable	14 AWG	14 AWG	16-20 AWG	16-20 AWG	22 AWG	26 AWG
Contact Resistance:	<10mΩ					
Insulation Resistance:	>10 ⁹ MΩ @500V DC					
AC Breakdown voltage:						
2 Contact	>10kV					
3 Contact	>8kV					
4 to 22 Contact	>5kV					
Operating Temp. Range:	-40°C to +120°C					
Approvals:						
 UL (E214972)	UL1977					
 cULus (E214972)	C22.2 No.182.3-M1987 (R2009)					
 VDE (40039281)	IEC 61984:2009					

Mechanical:

Locking mechanism	Push/pull with 30° locking
Sealing:	IP66 to En60529:1992+A2:2013 IP68 to En60529:1992+A2:2013 (10m depth for 2 weeks) IP69k to DIN 40050-9
Salt Mist (plastic) :	EN60068-2-52 Test Kb Salt Mist (Cyclic) Marine Severity Level 1
Salt Mist (metal) :	EN60068-2-11 Test Ka Salt Mist
Contact Accommodation:	
2 & 3 Contact crimp / solder	14 to 18AWG
2 & 3 Contact screw terminals	16 AWG Max
4 & 8 Contact crimp / solder	18 to 20AWG
16 Contact crimp / solder	22 to 26AWG
22 Contact crimp / solder	22 to 26AWG
Cable Acceptance:	4-10mm dia.
Cable retention force (to BS EN61984):	
4 - 9mm dia cable	80N
9 - 10mm dia cable	100N
Terminations:	
2 Contact:	Screw Terminals
3 Contact:	Screw, crimp or solder terminals
4 Contact:	Crimp / Solder Contacts
8 Contact:	Crimp / Solder Contacts
16 Contact:	Crimp / Solder Contacts
22 Contact:	Crimp / Solder Contacts
Tightening Torques:	
Gland Nut:	1.13Nm (10lb.in.)
Panel Nut:	1.7Nm (15lb.in.)
PXP 6014	2Nm (17.7lb.in.)
Panel Nut Thread:	M22 x 1.5-6g
Dimensions:	
Diameter: (over coupling ring)	32mm
Diameter: (panel hole cut-out)	22.5mm

Materials:

Plastic

Metal

Body:	PC/ PBT	Brass
Colour:	Grey	Matt silver
Contacts:	Brass, Nickel Plate (Screw and Crimp) Brass, (3A – Gold plated)	Brass, Nickel Plate (Screw and Crimp) Brass, (3A – Gold plated)
O Rings & Gaskets:	Silicone	Silicone
Flammability Rating:	UL94 V-0	-
Halogen free	Yes	-
UV Resistance:	ISO 4892 part 3 cycle 1 (QUV)	-
RoHS	Compliant	Compliant

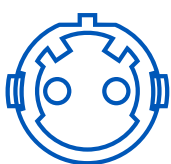

2 Contact

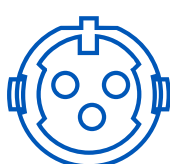

3 Contact

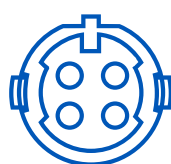

4 Contact

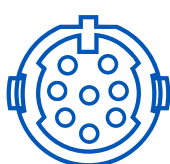

8 Contact

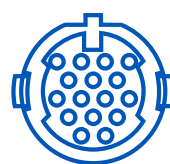

16 Contact

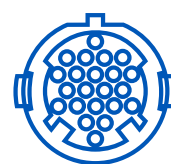

22 Contact



The thermal properties of the materials used in the construction of a connector limit the current carrying capacity. There are a number of factors that determine the amount of current that can be handled: contact spacing, size of cable, ambient temperature and the heat that is generated by the current passing through the connector.

The maximum current varies with different contact layouts, and because of these factors it is necessary to produce de-rating curves for each contact variant. This de-rating curve is specified in the standard IEC 60512 part 3. De-rating curves are plotted for each contact carrier combination with the current being carried simultaneously by all contacts. These graphs show the heat rise generated as the current is increased.

The red line indicates the direct correlation between current applied and the measured temperature rise within the connector. The dotted blue line shows rated current and the green line is derived by applying a factor of 0.8 to the original plot data to give a de-rating curve. The dashed blue line shows the rated current.

The shaded area under the 0.8 curve shows the permitted operating area, and allows safe current vs ambient temperature characteristics to be determined.

- = tested operating limits
- = de-rated operating limits
- - - = rated current

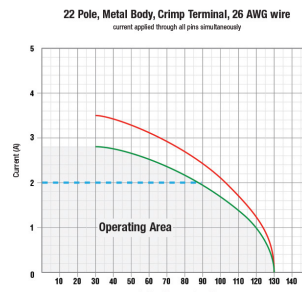
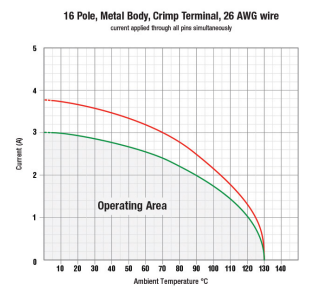
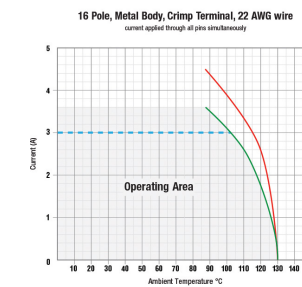
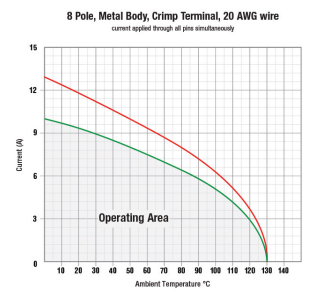
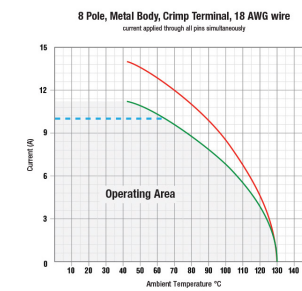
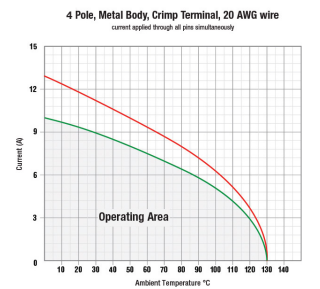
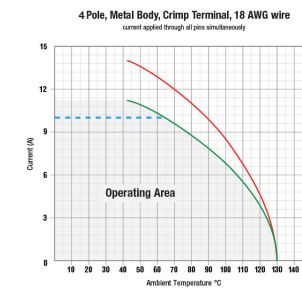
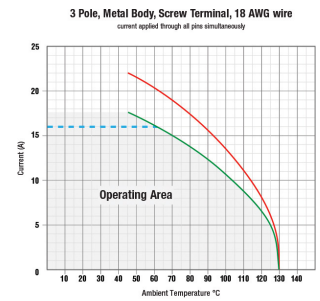
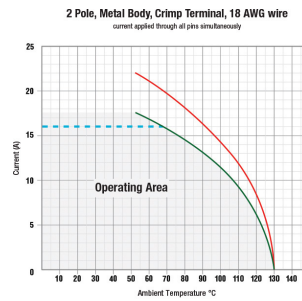

The all plastic and metal construction of the 7000 Series Buccaneer - **circular connectors** that combine the ease of use of a **quick** coupling mechanism with **proven** environmental sealing for signal and mains **power**.

Designed and independently tested to IP66, IP68 & IP69K standards, they are ideal for applications where ingress of dust and water must be avoided and where ease of connection, space and appearance are important considerations.

- **Less than 1/4 Turn locking mechanism**
Secure, quick connector mating and release
- **Positive feedback on locking mechanism**
Confidence that connector is correctly mated and sealed
- **IP66, IP68 and IP69K when mated**
Suitable for a wide range of dust and water borne environments
- **All plastic body version; UL94-V0 rated, UV stable, halogen free**
Light-weight, self-extinguishing material suitable for long-term outdoor use
- **Flex, Inline & panel mount body styles, with sealing caps**
Complete family of products maintain sealing integrity in all styles
- **Polarisation and visual alignment features**
Aids the correct mating of connectors
- **2 to 32 Contacts – up to 25A, 600V rated**
Suitable for mains power to signal applications
- **'Scoop proof' contacts**
Prevents damage through mis-mating – ideal for 'blind mating' applications
- **cULus, approvals**
- **Screw, Crimp and Solder terminations available**
- **EN60068-2-52 Test Kb Salt Mist (Cyclic)**
Marine Severity Level 1



BUCCANEER FOR POWER
7000 Series Buccaneer

Thermo Plastic



Flex Cable Connector



PXP7010

- Mates with Inline or Panel Mounting versions PXP7011 & PXP7012
- Quick turn locking ring
- Plug or socket versions
- Leading earth on 3 Contact connectors
- 2, 3, 6, 10 & 32 Contact
- Screw solder and crimp termination

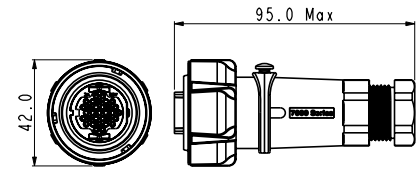

Contacts	Termination	Plug Contacts	Socket Contacts	Contacts
2	Screw	PXP7010/02P/ST	PXP7010/02S/ST	Supplied Fitted
3	Screw	PXP7010/03P/ST	PXP7010/03S/ST	Supplied Fitted
6	Screw	PXP7010/06P/ST	PXP7010/06S/ST	Supplied Fitted
10	Crimp / Solder	PXP7010/10P/CR	PXP7010/10S/CR	Contact Required
32	Crimp / Solder	PXP7010/32P/CR	PXP7010/32S/CR	Contact Required

Inline Cable Connector



PXP7011

- Mates with Flex Cable connector PXP7010
- For Inline cable connection
- Plug or socket versions
- Leading earth on 3 Contact connectors
- 2, 3, 6, 10 and 32 Contact
- Screw solder and crimp termination

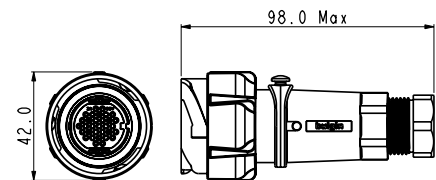

Contacts	Termination	Plug Contacts	Socket Contacts	Contacts
2	Screw	PXP7011/02P/ST	PXP7011/02S/ST	Supplied Fitted
3	Screw	PXP7011/03P/ST	PXP7011/03S/ST	Supplied Fitted
6	Screw	PXP7011/06P/ST	PXP7011/06S/ST	Supplied Fitted
10	Crimp / Solder	PXP7011/10P/CR	PXP7011/10S/CR	Contact Required
32	Crimp / Solder	PXP7011/32P/CR	PXP7011/32S/CR	Contact Required

Front Panel Mounting Connector



PXP7012

- Mates with Flex Cable connectors PXP7010
- Single hole fixing
- Plug or socket versions
- Leading earth on 3 Contact connectors
- 2, 3, 6, 10 and 32 Contact
- Screw solder and crimp termination

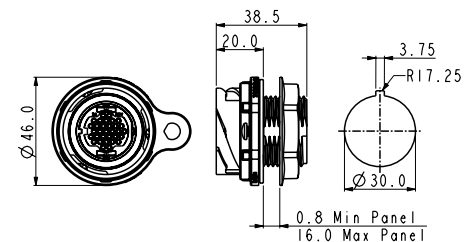

Contacts	Termination	Plug Contacts	Socket Contacts	Contacts
2	Screw	PXP7012/02P/ST	PXP7012/02S/ST	Supplied Fitted
3	Screw	PXP7012/03P/ST	PXP7012/03S/ST	Supplied Fitted
6	Screw	PXP7012/06P/ST	PXP7012/06S/ST	Supplied Fitted
10	Crimp / Solder	PXP7012/10P/CR	PXP7012/10S/CR	Contact Required
32	Crimp / Solder	PXP7012/32P/CR	PXP7012/32S/CR	Contact Required

BUCCANEER FOR POWER
7000 Series Buccaneer

Metal Version



Flex Cable Connector



PXM7010

- Mates with Inline or Panel Mounting versions PXM7011 & PXM7012
- Quick turn locking ring
- Plug or socket versions
- Leading earth on 3 Contact connectors
- 2, 3, 6, 10 & 32 Contact
- Screw solder and crimp termination
- Cable braid termination accessory option, add /SNSuffix

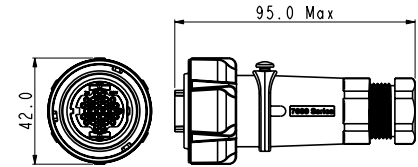

Contacts	Termination	Plug Contacts	Socket Contacts	Contacts
2	Screw	PXM7010/02P/ST	PXM7010/02S/ST	Supplied Fitted
3	Screw	PXM7010/03P/ST	PXM7010/03S/ST	Supplied Fitted
6	Screw	PXM7010/06P/ST	PXM7010/06S/ST	Supplied Fitted
10	Crimp / Solder	PXM7010/10P/CR	PXM7010/10S/CR	Contact Required
32	Crimp / Solder	PXM7010/32P/CR	PXM7010/32S/CR	Contact Required

Inline Cable Connector



PXM7011

- Mates with Flex Cable connector PXM7010
- For Inline cable connection
- Plug or socket versions
- Leading earth on 3 Contact connectors
- 2, 3, 6, 10 and 32 Contact
- Screw solder and crimp termination
- Cable braid termination accessory option, add /SNSuffix

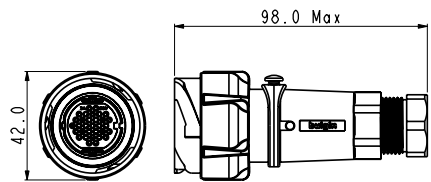

Contacts	Termination	Plug Contacts	Socket Contacts	Contacts
2	Screw	PXM7011/02P/ST	PXM7011/02S/ST	Supplied Fitted
3	Screw	PXM7011/03P/ST	PXM7011/03S/ST	Supplied Fitted
6	Screw	PXM7011/06P/ST	PXM7011/06S/ST	Supplied Fitted
10	Crimp / Solder	PXM7011/10P/CR	PXM7011/10S/CR	Contact Required
32	Crimp / Solder	PXM7011/32P/CR	PXM7011/32S/CR	Contact Required

Front Panel Mounting Connector



PXM7012

- Mates with Flex Cable connectors PXM7010
- Single hole fixing
- Plug or socket versions
- Leading earth on 3 Contact connectors
- 2, 3, 6, 10 and 32 Contact
- Screw solder and crimp termination

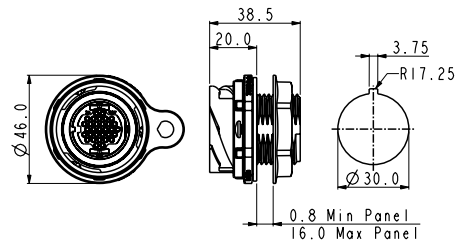



Contacts	Termination	Plug Contacts	Socket Contacts	Contacts
2	Screw	PXM7012/02P/ST	PXM7012/02S/ST	Supplied Fitted
3	Screw	PXM7012/03P/ST	PXM7012/03S/ST	Supplied Fitted
6	Screw	PXM7012/06P/ST	PXM7012/06S/ST	Supplied Fitted
10	Crimp / Solder	PXM7012/10P/CR	PXM7012/10S/CR	Contact Required
32	Crimp / Solder	PXM7012/32P/CR	PXM7012/32S/CR	Contact Required

<p>Crimp / Solder Contacts</p>  <p>10 & 32 Contacts</p>	<ul style="list-style-type: none"> ○ Gold Plated ○ Current ratings: 10 Contact: 10A 32 Contact: 2A 	<table border="1"> <tr> <td>Contacts (for 10 Contact) (Supplied in packs of 10)</td> <td>Crimp</td> <td>Solder</td> </tr> <tr> <td>Plugs</td> <td>SA3544/P</td> <td>SA3623/P</td> </tr> <tr> <td>Sockets</td> <td>SA3544/S</td> <td>SA3623/S</td> </tr> <tr> <td>Contacts (for 32 Contact) (Supplied in packs of 10)</td> <td>Crimp</td> <td>Solder</td> </tr> <tr> <td>Plugs</td> <td>SA3542/P</td> <td>SA3622/P</td> </tr> <tr> <td>Sockets</td> <td>SA3542/S</td> <td>SA3622/S</td> </tr> </table>	Contacts (for 10 Contact) (Supplied in packs of 10)	Crimp	Solder	Plugs	SA3544/P	SA3623/P	Sockets	SA3544/S	SA3623/S	Contacts (for 32 Contact) (Supplied in packs of 10)	Crimp	Solder	Plugs	SA3542/P	SA3622/P	Sockets	SA3542/S	SA3622/S
Contacts (for 10 Contact) (Supplied in packs of 10)	Crimp	Solder																		
Plugs	SA3544/P	SA3623/P																		
Sockets	SA3544/S	SA3623/S																		
Contacts (for 32 Contact) (Supplied in packs of 10)	Crimp	Solder																		
Plugs	SA3542/P	SA3622/P																		
Sockets	SA3542/S	SA3622/S																		

<p>Crimp Tooling</p>  <p>PNo 14025</p>	<ul style="list-style-type: none"> ○ Crimp Tools for 10 and 32 Contact crimp contacts 	<p>Crimp Tooling</p> <table border="1"> <tr> <td>Crimp Tool (10 & 32 Contact)</td> <td>PNo. 14025</td> </tr> <tr> <td>Positioner (10 Contacts)</td> <td>PNo. 15021/SP</td> </tr> <tr> <td>Positioner (32 Contacts)</td> <td>PNo. 15019/SP</td> </tr> </table>	Crimp Tool (10 & 32 Contact)	PNo. 14025	Positioner (10 Contacts)	PNo. 15021/SP	Positioner (32 Contacts)	PNo. 15019/SP
Crimp Tool (10 & 32 Contact)	PNo. 14025							
Positioner (10 Contacts)	PNo. 15021/SP							
Positioner (32 Contacts)	PNo. 15019/SP							

<p>Extraction Tools</p>  <p>PNo 14944/SP PNo 14945/SP</p>	<ul style="list-style-type: none"> ○ Extraction tool for 10 and 32 Contact contacts 	<p>Extraction Tools</p> <table border="1"> <tr> <td>Extraction tool (10 Contacts)</td> <td>PNo. 14945/SP</td> </tr> <tr> <td>Extraction tool (32 Contacts)</td> <td>PNo. 14944/SP</td> </tr> </table>	Extraction tool (10 Contacts)	PNo. 14945/SP	Extraction tool (32 Contacts)	PNo. 14944/SP
Extraction tool (10 Contacts)	PNo. 14945/SP					
Extraction tool (32 Contacts)	PNo. 14944/SP					

<p>Contact Carrier Removal Tool</p>  <p>PNo 15065/SP</p>	<ul style="list-style-type: none"> ○ For removal of all contact carriers 	<p>Contact Carrier Removal Tool</p> <table border="1"> <tr> <td>Contact carrier removal tool (all Contacts)</td> <td>PNo. 15065/SP</td> </tr> </table>	Contact carrier removal tool (all Contacts)	PNo. 15065/SP
Contact carrier removal tool (all Contacts)	PNo. 15065/SP			

<p>Cable Braid Termination Option</p>  <p>PXM7090</p>	<ul style="list-style-type: none"> ○ For cable braid termination ○ Supplied with ty-rap
--	---

Sealing Caps



PXP7082 PXP7081

- Maintains IP rating of unmated connectors
- PXP7081: Fits PXP7010 (Flex Connector)
- PXP7082: Fits PXP7011 (Inline Connector) and PXP7012: (Panel Connector)

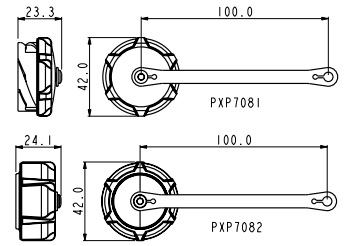

Sealing Caps



PXM7082 PXM7081 PXM7083

- Maintains IP rating of unmated connectors
- PXM7081: Fits PXM7010 (Flex Connector)
- PXM7082: Fits PXM7011 (Inline Connector) and PXP7012: (Panel Connector)
- PXM7083: Fits PXM7012 (Panel Mounting Connector)

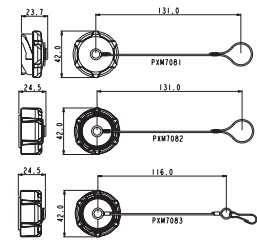

Cable Gland Packs



PXP7088/ *

- Packs of cable glands, cages and gland nuts to suit cables ranges from 5.0 to 15.0mm diameter
- PXP7088/0507: for cable ranges between 5.0 and 7.0mm
- PXP7088/0713: for cable ranges between 7.0 and 13.0mm
- PXP7088/1315: for cable ranges between 13.0 and 15.0mm



PXX	701X	/	XX	X	/	XX	/	XXXX	/	XX
Series Designation	Series / Body Style	No. of Contacts	Contacts Type	Terminations	Cable Entry Size	Cable Brand Termination Accessory				
PXM= Metal Series PXP= Plastic Series	7010 = Flex 7011 = Inline 7012 = Front Panel	02 03 06 10 32	P = Plug S = Socket	ST = Screw Terminal (2, 3, & 6 Contacts only) CR = Contacts Required (10 & 32 Contacts only)	(for Flex and Inline connectors only) 0507 = 5-7mm (grey) 0709 = 7-9mm (white) 0911 = 9-11mm (black) 1113 = 11 to 13 mm (yellow) 1315 = 13 to 15 mm (light grey)	(for Flex and Inline connectors only) SN - If requires Blank - If not required				

Examples

PXM7010/10/P/CR/0911/SN= Flex cable connector, 10 Contacts, Plug contacts with 9 to 11mm cable glands and braid termination accessory

PXM7012/03/S/ST= Front panel mounting connector, 3 Contacts, socket with screw termination



Electrical:

No Contacts:	2	3	6	10	32
Current Rating:					
UL	25A	25A	10A	10A	3A
cUL (pending)	25A	25A	8A	6A	2A
Voltage Rating (AC/DC):					
UL, cUL (pending)	600V	600V	600V	600V	600V
Contact Resistance:	<10mΩ				
Insulation Resistance:	>10 ⁹ MΩ @500V DC				
AC Breakdown voltage:					
2 Contacts	>10kV				
3 Contacts	>8kV				
6 to 32 Contacts	>5kV				
Operating Temp. Range:	-40°C to +120°C				
Approvals:					
UL	UL1977				
cULus	E214972)				

Mechanical:

Locking mechanism	Quarter turn, rapid locking
Sealing:	IP66 to EN60529:1992+A2:2013 IP68 to EN60529:1992+A2:2013 (10m depth for 2 weeks) IP69k to DIN 40050-9
Salt Mist (plastic):	EN60068-2-52 Test Kb Salt Mist (Cyclic) Marine Severity Level 1
Salt Mist (metal):	EN60068-2-11 Test Ka Salt Mist
Contact Accommodation:	
2 & 3 Contacts screw terminals	6.0mm ² max
6 Contacts screw	1.00mm ² max
10 Contacts crimp / solder	18 to 20AWG
32 Contacts crimp / solder	22 to 26AWG
Cable Acceptance:	5-15mm dia.
Cable retention force (to BS EN61984):	
5 - 9mm dia cable	80N
9 - 15mm dia cable	100N
Terminations	
2 Contacts:	Screw Terminals
3 Contacts:	Screw Terminals
6 Contacts:	Screw Terminals
10 Contacts:	Crimp / Solder Contacts
32 Contacts:	Crimp / Solder Contacts
Tightening Torques:	
Gland Nut:	1.13Nm (10lb.in)
Panel Nut:	1.7Nm (15lb.in.)
Panel Nut Thread	M30 x 2-6g
Dimensions:	
Diameter: (over coupling ring)	42mm
Diameter: (panel hole cut-out)	30mm

Materials:

Plastic

Metal

Body:	PC/ PBT	Cast zinc alloy, nickel plated
Colour:	Grey	Matt silver
Contacts:	Brass, Nickel Plate (Screw and Crimp) Brass, (3A – Gold plated)	Brass, Nickel Plate (Screw and Crimp) Brass, (3A – Gold plated)
O Rings & Gaskets:	Silicone	Silicone
Flammability Rating:	UL94 V-0	-
Halogen free	Yes	-
UV Resistance:	ISO 4892 part 3 cycle 1 (QUV)	-
RoHS	Compliant	Compliant



The thermal properties of the materials used in the construction of a connector limit the current carrying capacity. There are a number of factors that determine the amount of current that can be handled: contact spacing, size of cable, ambient temperature and the heat that is generated by the current passing through the connector.

The maximum current varies with different contact layouts, and because of these factors it is necessary to produce de-rating curves for each contact variant. This de-rating curve is specified in the standard IEC 60512 part 3. De-rating curves are plotted for each contact carrier combination with the current being carried simultaneously by all contacts. These graphs show the heat rise generated as the current is increased.

The red line indicates the direct correlation between current applied and the measured temperature rise within the connector. The dotted blue line shows rated current and the green line is derived by applying a factor of 0.8 to the original plot data to give a de-rating curve. The dashed blue line shows the rated current.

The shaded area under the 0.8 curve shows the permitted operating area, and allows safe current vs ambient temperature characteristics to be determined.

- = tested operating limits
- = de-rated operating limits
- - - = rated current

7000 Series Current vs. Temperature Characteristics

2 Pole, Plastic Body, Screw Terminal, 6.0mm² wire
current applied through all pins simultaneously

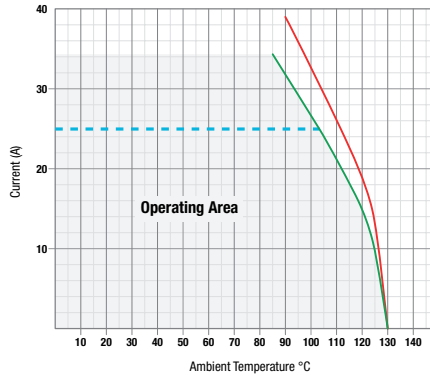

7000 Series Current vs. Temperature Characteristics

3 Pole, Plastic Body, Screw Terminal, 4.0mm² wire
current applied through all pins simultaneously

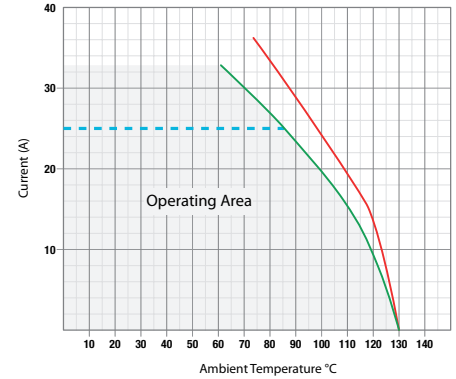

7000 Series Current vs. Temperature Characteristics

6 Pole, Plastic Body, Screw Terminal, 1.0mm² wire
current applied through all pins simultaneously

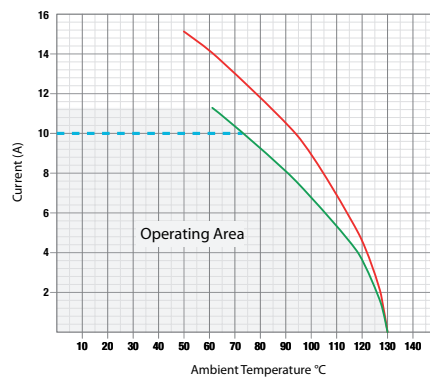

7000 Series Current vs. Temperature Characteristics

10 Pole, Plastic Body, Crimp Terminal, 18 AWG wire
current applied through all pins simultaneously

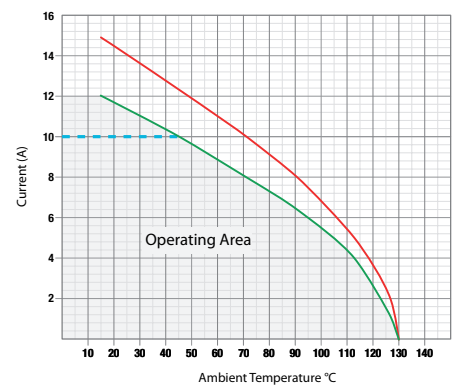

7000 Series Current vs. Temperature Characteristics

32 Pole, Plastic Body, Crimp Terminal, 22 AWG wire
current applied through all pins simultaneously

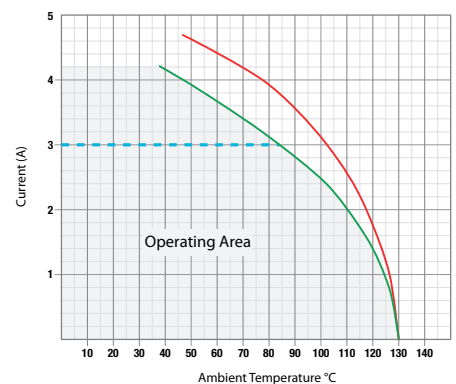

A range of high **amperage** flex body, flex body inline and flange mount connectors rated to IP68. These **Delrin housing** multi pin circular connectors are ideal for applications where **dust** and **water ingress** must be **avoided** and ease of connection to high ratings must be achieved.

- **Bayonet 1/4 Turn locking Mechanism**
Secure, quick connector mating and release
- **Screw Turn Locking**
Secure, robust connection and easy to disconnect
- **Positive feedback on locking mechanism**
Confidence that connector is correctly mated and sealed
- **IP68 when mated (for parts with backshell)**
Suitable for a wide range of dust and water borne environments
- **Flex Body, Flex Body Inline and Flange Mount Available**
Complete family of products maintain sealing integrity in all styles
- **Visual alignment features**
Aids the correct mating of connectors
- **2 to 11 Contacts - up to 225A, 1250V AC RMS**
Suitable for mains power to signal applications
- **Crimp termination available**
- **300+ AMP contacts upon request**



Screw Locking -
Male & Female



PXP9050

- Flex Body, Inline Body & Flange Mount available
- Plug and Socket available
- IP68 Rated
- Up to 1250V AC RMS

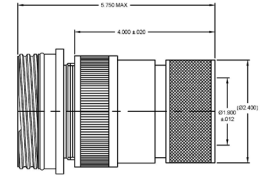
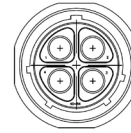

Part Number	Contacts	Contact Type	Contact Size	Body Type	Backshell
PXP9050/02/P/1	2	Plug	4/0	Flex	Yes
PXP9051/02/S/1	2	Socket	4/0	Inline	Yes
PXP9052/02/S	2	Socket	4/0	Flange Mount	-
PXP9050/04/P/1	4	Plug	1/0	Flex	Yes
PXP9051/04/S/1	4	Socket	1/0	Inline	Yes
PXP9052/04/S	4	Socket	1/0	Flange Mount	-
PXP9050/06/P/1	6	Plug	1/0	Flex	Yes
PXP9051/06/S/1	6	Socket	1/0	Inline	Yes
PXP9052/06/S	6	Socket	1/0	Flange Mount	-
PXP9050/08/P/1	8	Plug	4x 4 & 16AWG 4x	Flex	Yes
PXP9051/08/S/1	8	Socket	4x 4 & 16AWG 4x	Inline	Yes
PXP9052/08/S	8	Socket	4x 4 & 16AWG 4x	Flange Mount	-
PXP9050/11/P/1	11	Plug	10x 4 & 16AWG 1x	Flex	Yes
PXP9051/11/S/1	11	Socket	10x 4 & 16AWG 1x	Inline	Yes
PXP9052/11/S	11	Socket	10x 4 & 16AWG 1x	Flange Mount	-

Bayonet Quarter Turning Lock -
Male & Female



PXP9010

- Flex Body, Inline Body & Flange Mount available
- Plug and Socket available
- IP68 Rated
- Up to 1250V AC RMS
- Robust, with Quick Disconnect System

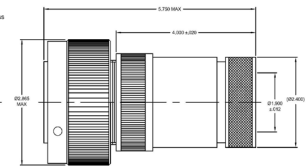
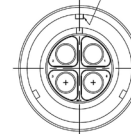

Part Number	Contacts	Contact Type	Contact Size	Body Type	Backshell
PXP9010/02/P/1	2	Plug	4/0	Flex	Yes
PXP9011/02/S/1	2	Socket	4/0	Inline	Yes
PXP9012/02/S	2	Socket	4/0	Flange Mount	-
PXP9010/04/P/1	4	Plug	1/0	Flex	Yes
PXP9011/04/S/1	4	Socket	1/0	Inline	Yes
PXP9012/04/S	4	Socket	1/0	Flange Mount	-
PXP9010/06/P/1	6	Plug	1/0	Flex	Yes
PXP9011/06/S/1	6	Socket	1/0	Inline	Yes
PXP9012/06/S	6	Socket	1/0	Flange Mount	-
PXP9010/08/P/1	8	Plug	4x 4 & 16AWG 4x	Flex	Yes
PXP9011/08/S/1	8	Socket	4x 4 & 16AWG 4x	Inline	Yes
PXP9012/08/S	8	Socket	4x 4 & 16AWG 4x	Flange Mount	-
PXP9010/11/P/1	11	Plug	10x 4 & 16AWG 1x	Flex	Yes
PXP9011/11/S/1	11	Socket	10x 4 & 16AWG 1x	Inline	Yes
PXP9012/11/S	11	Socket	10x 4 & 16AWG 1x	Flange Mount	-

Adapter



PXP9080

○ Adapter

*crimping tool required - contact us for more details.

Part Number

Description

PXP9080

1/0 Plug and Socket Adapter to accommodate 6-8AWG conductors

Tooling



PXP9081 PXP9082 PXP9083

- Tooling:
 Pneumatic Tool Press
 Tooling Locator
 Tool Die Set

Part Number

Description

PXP9081
 PXP9082
 PXP9083

Pneumatic Tool Press
 Tooling Locator
 Tool Die Set

