



Mains Filters

Designed to reduce conducted mains borne EMI, this extensive range provides many solutions to EMI problems. To meet individual design requirements the filters are available with two attenuation options – standard and medical. Current ratings are from 1 to 10 amps with single or twin fused types also available.

The choice of mounting options will suit most applications with flange, snap to panel or base/bulkhead.

Type	Page
Flange and Snap Fit	
PS00 Series	120-123
PS01 Series	120-123
Base Mounting and Bulkhead	
PS02 Series	124-127
PS03 Series	124-127
Fused Inlets	
PS20 Series	128-129
PS21 Series	128-129
PS22 Series	130-131
PS23 Series	130-131
PS25 Series	132-135
PS26 Series	132-135

IEC Power Inlets Flange and Snap Fit

PANEL MOUNTING



Flange PS00/A

- 1, 3, 6 or 10 Amp Current Rating
- 3 Alternative Circuits
- Optional Additional Components
- 2.8 or 6.3mm tabs

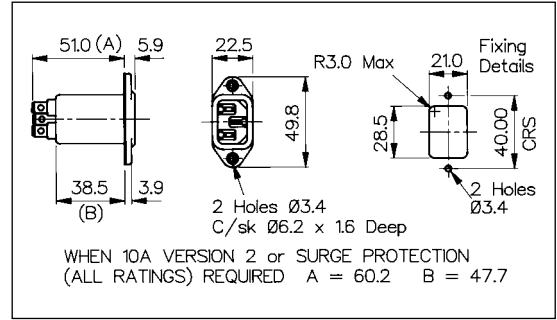

SNAP FIT



Snap Fit PS01/A

- 1, 3, 6 or 10 Amp Current Rating
- 3 Alternative Circuits
- Optional Additional Components
- 2.8 or 6.3mm tabs
- 1, 1.5, 2 or 3mm panels

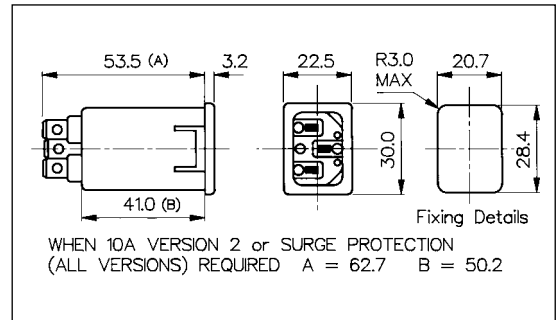

IEC CONNECTORS

PS00 or PS01/Axx xx /xx xx

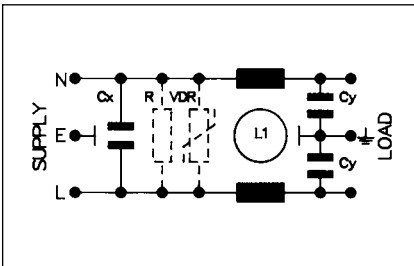

Series	Rating	L/C Circuit	Additional Components	Tag Type and Configuration	Panel Thickness
PS00/A	01 = 1A	1 = Version 1	0 = None	28 = 2.8mm	00 = Flange
PS01/A	03 = 3A	2 = Version 2	1 = Bleed (R) Resistor	63 = 6.3mm tabs	10 = 1.0mm
	06 = 6A	3 = Version 3	2 = Surge (VDR) Protection		15 = 1.5mm
	10 = 10A		3 = "R" plus "VDR"		20 = 2.0mm
					30 = 3.0mm

Specification	PS00/Axxxx/xx00	PS01/Axxxx/xxxx	Part No. Example
Max. Working Voltage:	250V a.c. 50-400Hz	250V a.c. 50-400Hz	PS00/A0120/6300 = PS00 series, flange fitting, standard filtered IEC power inlet, rated at 1 ampere. L/C circuit version 2, i.e. L1 = 2 x 10mH, Cx = 15nF, Cy = 2 x 2.2nF, without bleed resistor or surge protection device fitted, with 6.3mm tabs.
Earth Leakage Current:	<0.35mA (250V, 50Hz)	<0.35mA (250V, 50Hz)	
Temperature Range:	-25°C to +85°C	-25°C to +85°C	
Max. Ambient Temp.: (@ Full Load)	40°C (derate linearly to 0A @ 85°C)	40°C (derate linearly to 0A @ 85°C)	
Test Voltage:	2700V d.c. 2 secs. Lines to Earth 1100V d.c. 2 secs. Live to Neutral	2700V d.c. 2 secs. Lines to Earth 1100V d.c. 2 secs. Live to Neutral	
Approvals:			
Mating Connectors:	PX0587, PX0587/SE, PX0588 PZ0100, PZ0200	PX0587, PX0587/SE, PX0588 PZ0100, PZ0200	
RoHS	Compliant	Compliant	

Rating & Version Table

PS00/Axxxx/xx00 & PS01/Axxxx/xxxx

Rating	Version	L1	Cx	Cy
1 AMP	1	2 x 2.8mH	1 x 15nF	2 x 2.2nF
"	2	2 x 10mH	1 x 15nF	2 x 2.2nF
"	3	2 x 10mH	1 x 47nF	2 x 2.2nF
3 AMP	1	2 x 0.75mH	1 x 15nF	2 x 2.2nF
"	2	2 x 1.8mH	1 x 15nF	2 x 2.2nF
"	3	2 x 1.8mH	1 x 47nF	2 x 2.2nF
6 AMP	1	2 x 0.3mH	1 x 15nF	2 x 2.2nF
"	2	2 x 0.7mH	1 x 15nF	2 x 2.2nF
"	3	2 x 0.7mH	1 x 47nF	2 x 2.2nF
10 AMP	1	2 x 0.17mH	1 x 15nF	2 x 2.2nF
"	2	2 x 0.35mH	1 x 15nF	2 x 2.2nF
"	3	2 x 0.17mH	1 x 47nF	2 x 2.2nF

IEC CONNECTORS

Version 1

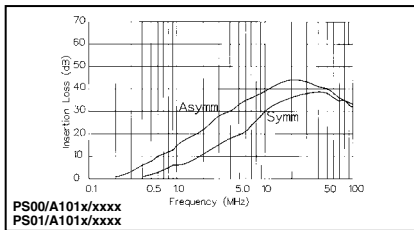
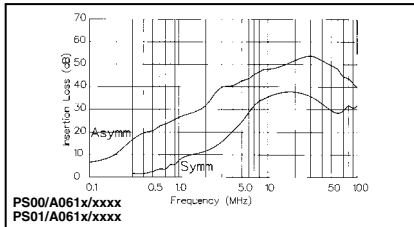
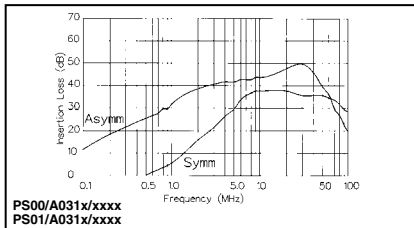
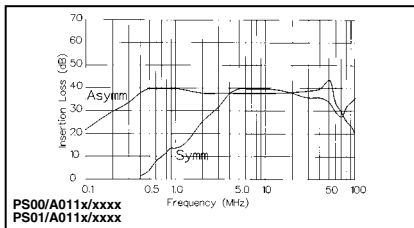

Version 2

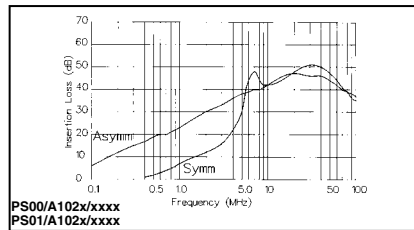
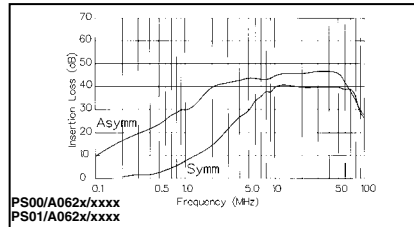
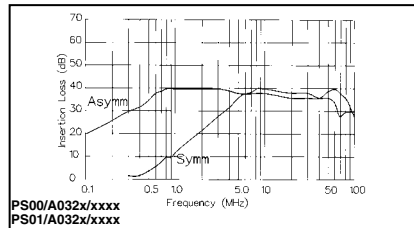
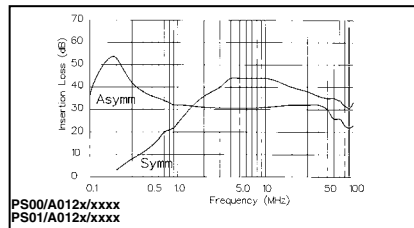

Version 3

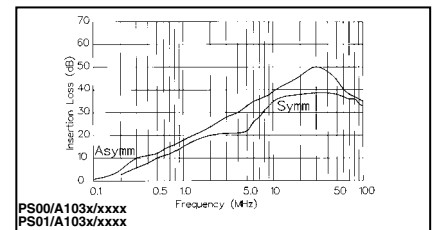
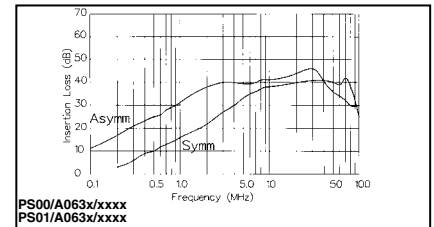
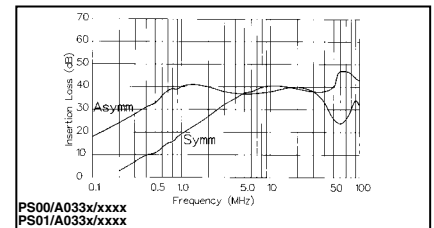
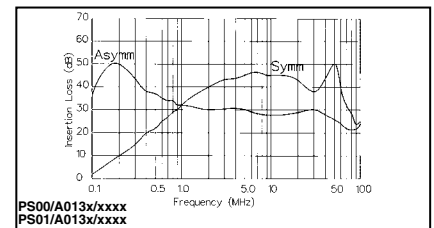

Medical IEC Power Inlets Flange and Snap Fit

PANEL MOUNTING



Flange PS00/B

- 1, 3, 6 or 10 Amp Current Rating
- Medical
- 3 Alternative Circuits
- Optional Additional Components
- 2.8 or 6.3mm tabs

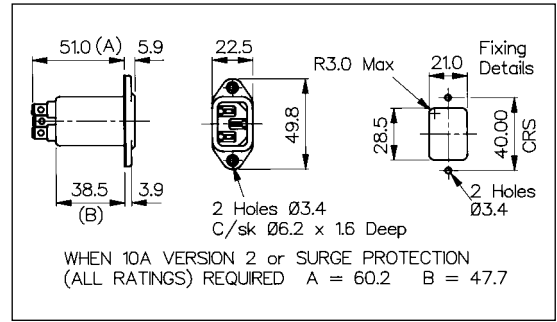

SNAP FIT



Snap Fit PS01/B

- 1, 3, 6 or 10 Amp Current Rating
- Medical
- 3 Alternative Circuits
- Optional Additional Components
- 2.8 or 6.3mm tabs
- 1, 1.5, 2 or 3mm panels

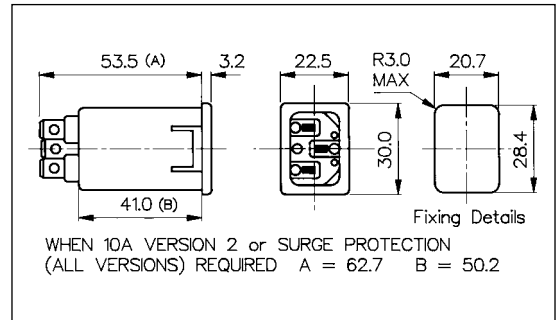

IEC CONNECTORS

PS00 or PS01/Bxx xx /xx xx

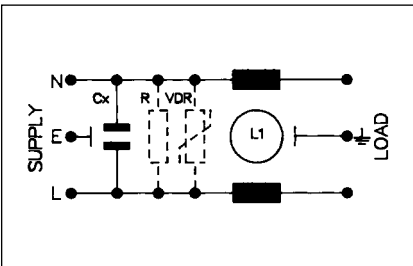

Series	Rating	L/C Circuit	Additional Components	Tag Type and Configuration	Panel Thickness
PS00/B	01 = 1A	1 = Version 1	0 = None	28 = 2.8mm	00 = Flange
PS01/B	03 = 3A	2 = Version 2	1 = Bleed (R) Resistor	63 = 6.3mm tabs	10 = 1.0mm
	06 = 6A	3 = Version 3	2 = Surge (VDR) Protection		15 = 1.5mm
	10 = 10A		3 = "R" plus "VDR"		20 = 2.0mm
					30 = 3.0mm

Specification	PS00/Bxxxx/xx00	PS01/Bxxxx/xxxx	Part No. Example
Max. Working Voltage:	250V a.c. 50-400Hz	250V a.c. 50-400Hz	PS00/B0120/6300 = PS00 series, flange fitting, filtered IEC power inlet, for medical applications, rated at 1 ampere. L/C circuit version 2, i.e. L1 = 2 x 10mH, Cx = 15nF, without bleed resistor or surge protection device fitted, with 6.3mm tabs.
Earth Leakage Current:	<100µA (typically 5µA 250V, 50Hz)	<100µA (typically 5µA 250V, 50Hz)	
Temperature Range:	-25°C to +85°C	-25°C to +85°C	
Max. Ambient Temp.: (@ Full Load)	40°C (derate linearly to 0A @ 85°C)	40°C (derate linearly to 0A @ 85°C)	
Test Voltage:	2700V d.c. 2 secs. Lines to Earth 1100V d.c. 2 secs. Live to Neutral	2700V d.c. 2 secs. Lines to Earth 1100V d.c. 2 secs. Live to Neutral	
Approvals:			
Mating Connectors:	PX0587, PX0587/SE, PX0588 PZ0100, PZ0200	PX0587, PX0587/SE, PX0588 PZ0100, PZ0200	
RoHS	Compliant	Compliant	

Rating & Version Table

PS00/Bxxxx/xx00 & PS01/Bxxxx/xxxx

Rating	Version	L1	Cx
1 AMP	1	2 x 2.8mH	1 x 15nF
"	2	2 x 10mH	1 x 15nF
"	3	2 x 10mH	1 x 47nF
3 AMP	1	2 x 0.75mH	1 x 15nF
"	2	2 x 1.8mH	1 x 15nF
"	3	2 x 1.8mH	1 x 47nF
6 AMP	1	2 x 0.3mH	1 x 15nF
"	2	2 x 0.7mH	1 x 15nF
"	3	2 x 0.7mH	1 x 47nF
10 AMP	1	2 x 0.17mH	1 x 15nF
"	2	2 x 0.35mH	1 x 15nF
"	3	2 x 0.17mH	1 x 47nF

Version 1

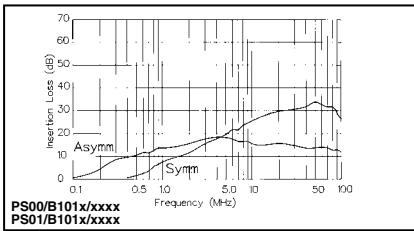
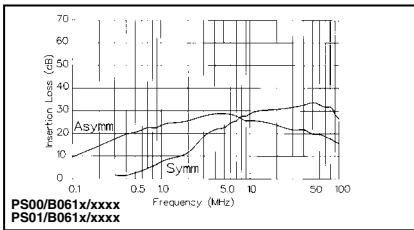
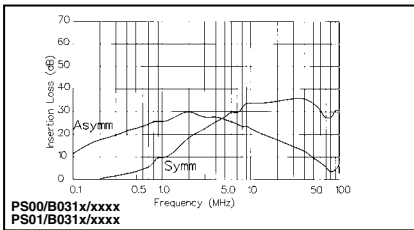
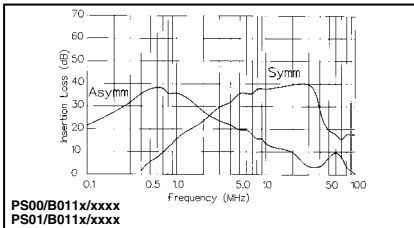

Version 2

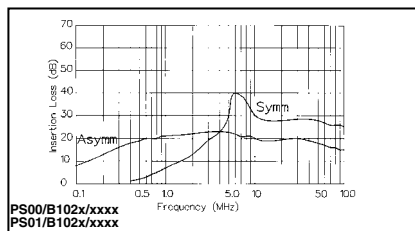
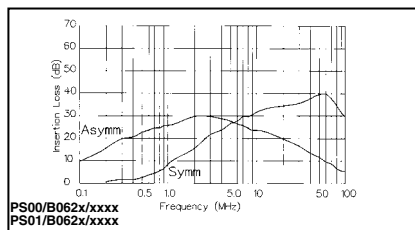
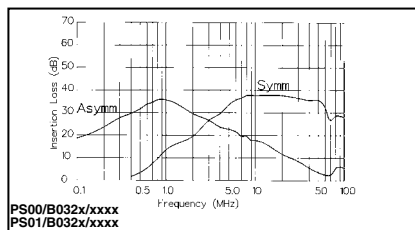
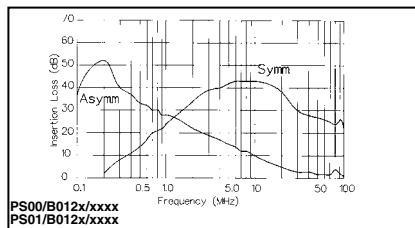

Version 3

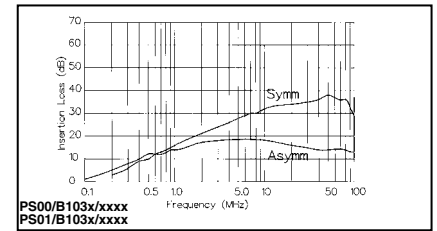
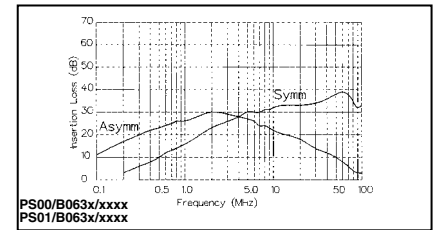
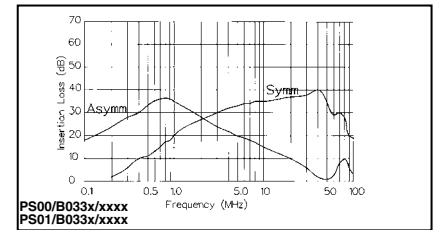
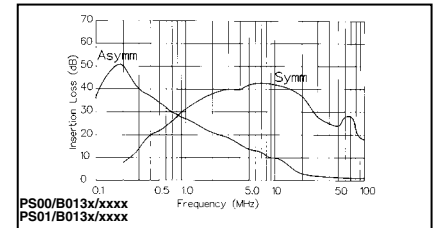

Base Mounting and Bulkhead

BASE MOUNTING



- 1, 3, 6 or 10 Amp Current Rating
- 3 Alternative Circuits
- Optional Additional Components
- 2.8 or 6.3mm tabs

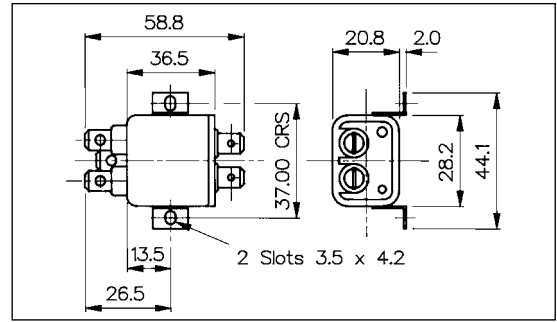

BULKHEAD MOUNTING



- 1, 3, 6 or 10 Amp Current Rating
- 3 Alternative Circuits
- Optional Additional Components
- 2.8 or 6.3mm tabs

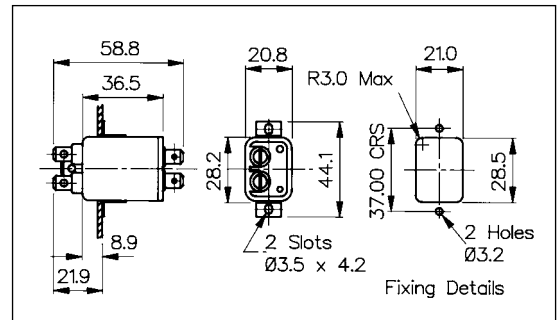

IEC CONNECTORS

PS02 or PS03/Axx xx /xx

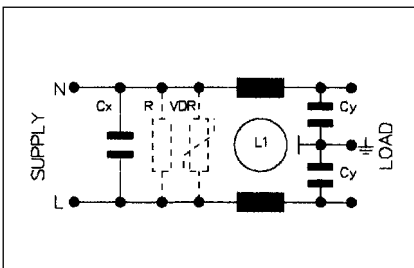

Series	Rating	L/C Circuit	Additional Components	Tag Type and Configuration
PS02/A	01 = 1A	1 = Version 1	0 = None	28 = 2.8mm
PS03/A	03 = 3A	2 = Version 2	1 = Bleed (R) Resistor	63 = 6.3mm tabs
	06 = 6A	3 = Version 3	2 = Surge (VDR) Protection	
	10 = 10A		3 = "R" plus "VDR"	

Specification	PS02/Axxxx/xx	PS03/Axxxx/xx	Part No. Example
Max. Working Voltage:	250V a.c. 50-400Hz	250V a.c. 50-400Hz	PS02/A0311/28 = PS02 series, standard base mounting filter, rated at 3 amperes. L/C circuit version 1, i.e. L1 = 2 x 0.75mH, Cx = 15nF, Cy = 2 x 2.2nF. with bleed resistor fitted, with 2.8mm tabs.
Earth Leakage Current:	<0.35mA (250V, 50Hz)	<0.35mA (250V, 50Hz)	
Temperature Range:	-25°C to +85°C	-25°C to +85°C	
Max. Ambient Temp.: (@ Full Load)	40°C (derate linearly to 0A @ 85°C)	40°C (derate linearly to 0A @ 85°C)	
Test Voltage:	2700V d.c. 2 secs. Lines to Earth 1100V d.c. 2 secs. Live to Neutral	2700V d.c. 2 secs. Lines to Earth 1100V d.c. 2 secs. Live to Neutral	
Approvals:			
	Compliant	Compliant	

Rating & Version Table
PS02/Axxxx/xx & PS03/Axxxx/xx

Rating	Version	L1	Cx	Cy
1 AMP	1	2 x 2.8mH	1 x 15nF	2 x 2.2nF
"	2	2 x 10mH	1 x 15nF	2 x 2.2nF
"	3	2 x 10mH	1 x 47nF	2 x 2.2nF
3 AMP	1	2 x 0.75mH	1 x 15nF	2 x 2.2nF
"	2	2 x 1.8mH	1 x 15nF	2 x 2.2nF
"	3	2 x 1.8mH	1 x 47nF	2 x 2.2nF
6 AMP	1	2 x 0.3mH	1 x 15nF	2 x 2.2nF
"	2	2 x 0.7mH	1 x 15nF	2 x 2.2nF
"	3	2 x 0.7mH	1 x 47nF	2 x 2.2nF
10 AMP	1	2 x 0.17mH	1 x 15nF	2 x 2.2nF
"	2	2 x 0.35mH	1 x 15nF	2 x 2.2nF
"	3	2 x 0.17mH	1 x 47nF	2 x 2.2nF

IEC CONNECTORS

Version 1

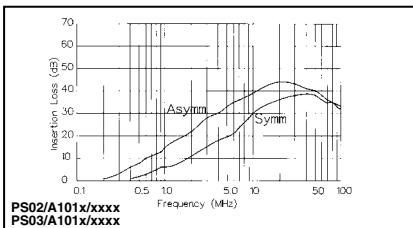
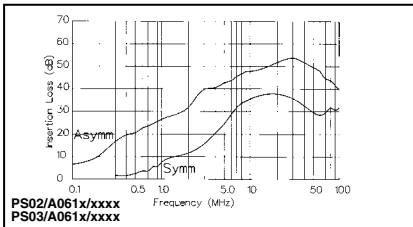
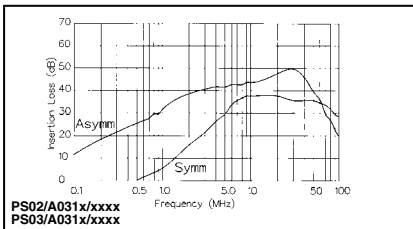
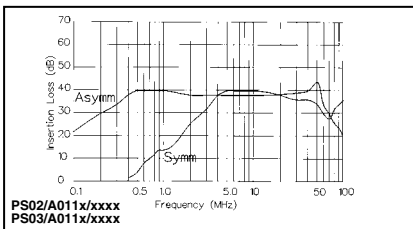

Version 2

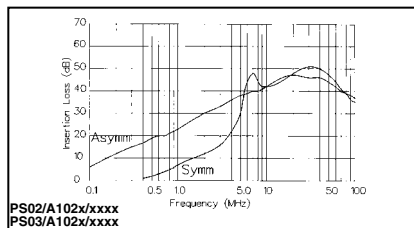
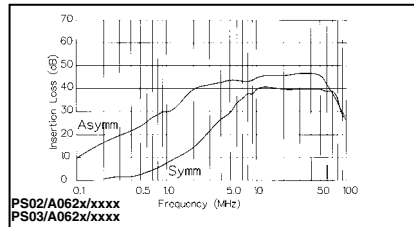
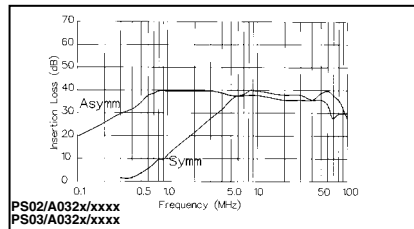
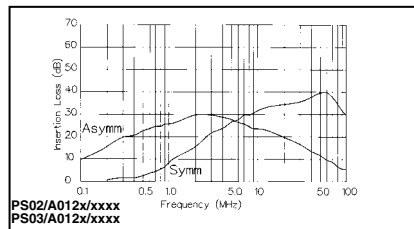

Version 3

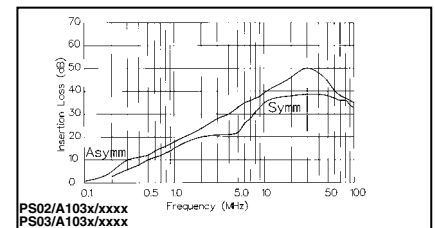
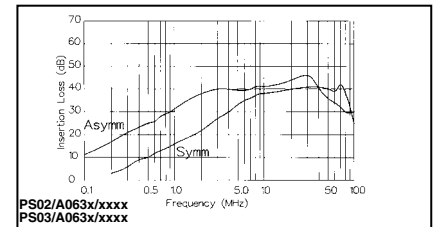
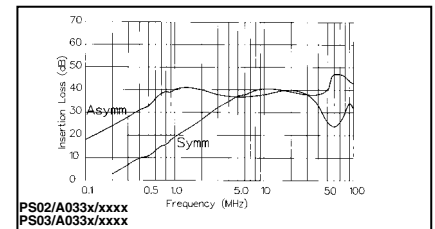
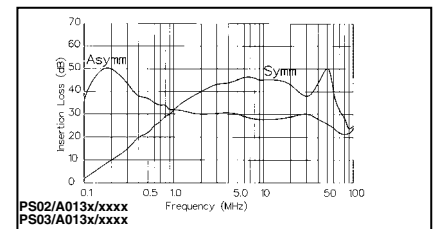

Medical Base Mounting and Bulkhead

BASE MOUNTING



- 1, 3, 6 or 10 Amp Current Rating
- Medical
- 3 Alternative Circuits
- Optional Additional Components
- 2.8 or 6.3mm tabs

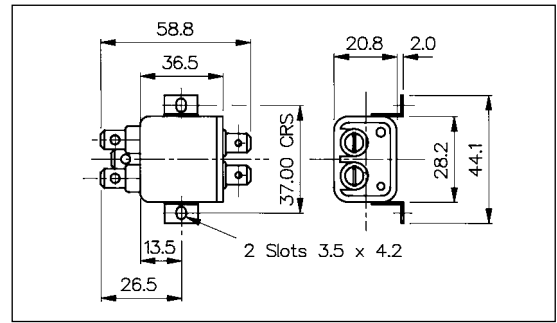

BULKHEAD MOUNTING



- 1, 3, 6 or 10 Amp Current Rating
- Medical
- 3 Alternative Circuits
- Optional Additional Components
- 2.8 or 6.3mm tabs

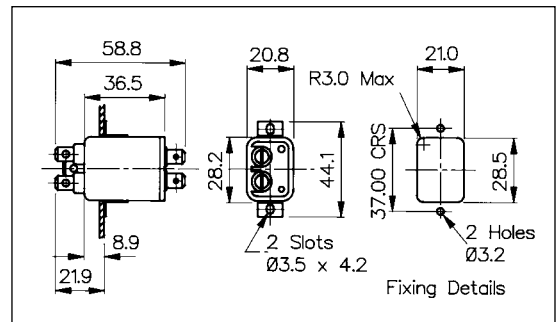

IEC CONNECTORS

PS02 or PS03/Bxx xx /xx

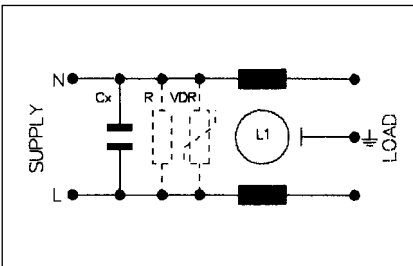

Series	Rating	L/C Circuit	Additional Components	Tag Type and Configuration
PS02/B	01 = 1A	1 = Version 1	0 = None	28 = 2.8mm
PS03/B	03 = 3A	2 = Version 2	1 = Bleed (R) Resistor	63 = 6.3mm tabs
	06 = 6A	3 = Version 3	2 = Surge (VDR) Protection	
	10 = 10A		3 = "R" plus "VDR"	

Specification	PS02/Bxxxx/xx	PS03/Bxxxx/xx	Part No. Example
Max. Working Voltage:	250V a.c. 50-400Hz	250V a.c. 50-400Hz	PS03/B0630/63 = PS03 series, bulkhead mounting for medical applications, rated at 6 amperes. L/C circuit version 3, i.e. L1 = 2 x 0.7mH, Cx = 47nF, without bleed resistor or surge protection device fitted, with 6.3mm tabs.
Earth Leakage Current:	<100µA (typically 5µA 250V, 50Hz)	<100µA (typically 5µA 250, 50Hz)	
Temperature Range:	-25°C to +85°C	-25°C to +85°C	
Max. Ambient Temp.: (@ Full Load)	40°C (derate linearly to 0A @ 85°C)	40°C (derate linearly to 0A @ 85°C)	
Test Voltage:	2700V d.c. 2 secs. Lines to Earth 1100V d.c. 2 secs. Live to Neutral	2700V d.c. 2 secs. Lines to Earth 1100V d.c. 2 secs. Live to Neutral	
Approvals:			
	Compliant	Compliant	

Rating & Version Table

PS02/Bxxxx/xx & PS03/Bxxxx/xx

Rating	Version	L1	Cx
1 AMP	1	2 x 2.8mH	1 x 15nF
	2	2 x 10mH	1 x 15nF
	3	2 x 10mH	1 x 47nF
3 AMP	1	2 x 0.75mH	1 x 15nF
	2	2 x 1.8mH	1 x 15nF
	3	2 x 1.8mH	1 x 47nF
6 AMP	1	2 x 0.3mH	1 x 15nF
	2	2 x 0.7mH	1 x 15nF
	3	2 x 0.7mH	1 x 47nF
10 AMP	1	2 x 0.17mH	1 x 15nF
	2	2 x 0.35mH	1 x 15nF
	3	2 x 0.17mH	1 x 47nF

Version 1

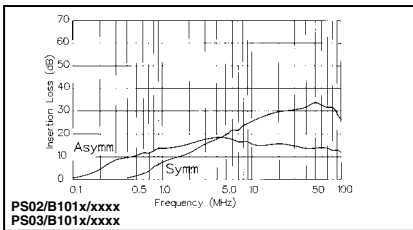
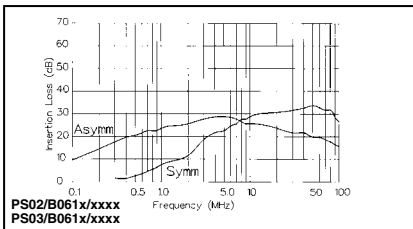
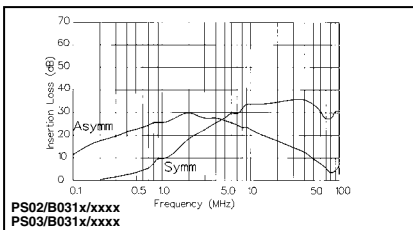
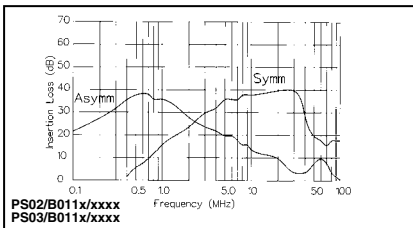

Version 2

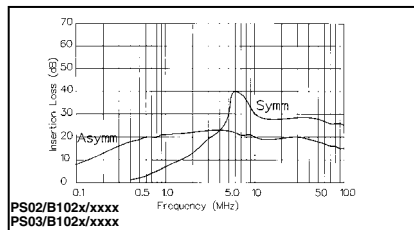
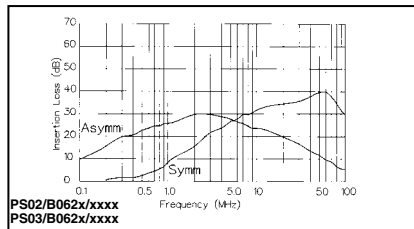
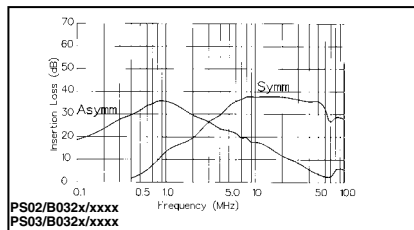
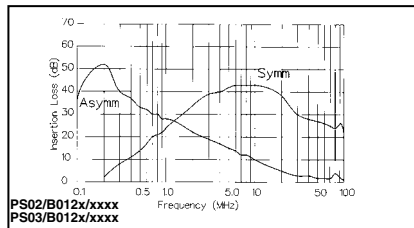

Version 3

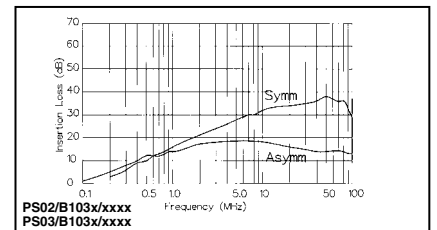
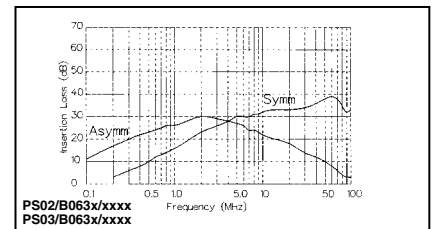
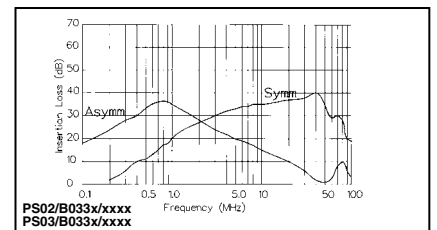
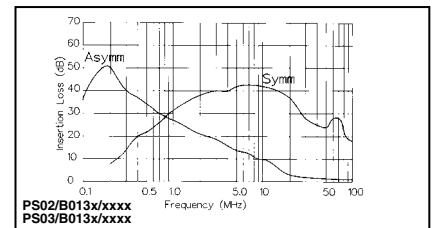

IEC Power Inlets (Single Fused)

PANEL MOUNTING



- 1, 3, or 6 Amp Current Rating
- Single Fused
- 2 Alternative Circuits
- 2.8 or 6.3mm tabs

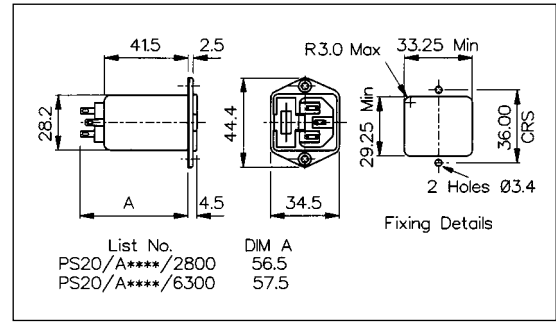

SNAP FIT



- 1, 3, or 6 Amp Current Rating
- Single Fused
- 2 Alternative Circuits
- 2.8 or 6.3mm tabs
- 1, 1.5, 2 or 3mm panels

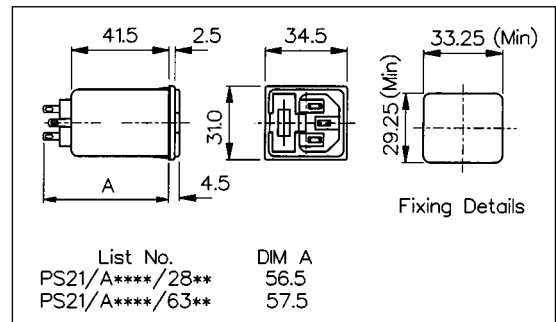

IEC CONNECTORS

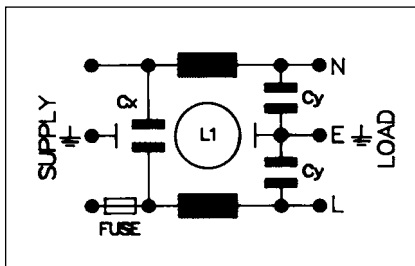

PS20 or PS21/Axx xx /xx xx

Series	Rating	L/C Circuit	Additional Components	Tag Type and Configuration	Panel Thickness
PS20/A	01 = 1A	3 = Version 3	0 = None	28 = 2.8mm	Blank = Flange
PS21/A	03 = 3A	2 = Version 2		63 = 6.3mm tabs	10 = 1.0mm
	06 = 6A	3 = Version 3			15 = 1.5mm
					20 = 2.0mm
					30 = 3.0mm

Specification	PS20/Axxx0/xx00	PS21/Axxx0/xxxx	Part No. Example
Max. Working Voltage:	250V a.c. 50-400Hz	250V a.c. 50-400Hz	PS20/A0620/63 = PS20 series, flange fitting, standard filtered IEC power inlet, single fused, rated at 6 amperes. L/C circuit version 2, i.e L1 = 2 x 0.7mH, Cx = 1 x 15nF, Cy = 2 x 2.2nF. Without bleed resistor or surge protection device fitted, with 6.3mm tabs.
Earth Leakage Current:	<0.35mA (250V, 50Hz)	<0.35mA (250V, 50Hz)	
Temperature Range:	-25°C to +85°C	-25°C to +85°C	
Max. Ambient Temp.: (@ Full Load)	40°C (derate linearly to 0A @ 85°C)	40°C (derate linearly to 0A @ 85°C)	
Test Voltage:	2700V d.c. 2 secs. Lines to Earth 1100V d.c. 2 secs. Live to Neutral	2700V d.c. 2 secs. Lines to Earth 1100V d.c. 2 secs. Live to Neutral	
Approvals:			
Mating Connectors:	PX0587, PX0587/SE, PX0588 PZ0100, PZ0200	PX0587, PX0587/SE, PX0588 PZ0100, PZ0200	
Accessories:	P.No. 14340 (see page 82)	P.No. 14340 (see page 82)	
RoHS	Compliant	Compliant	

Rating & Version Table

PS20/Axxx0/xx00 & PS21/Axxx0/xxxx

Rating	Version	L1	Cx	Cy
1 AMP	1			
"	2			
"	3	2 x 10mH	1 x 47nF	2 x 2.2nF
3 AMP	1			
"	2	2 x 1.8mH	1 x 15nF	2 x 2.2nF
"	3	2 x 6.5mH	1 x 47nF	2 x 2.2nF
6 AMP	1			
"	2	2 x 0.7mH	1 x 15nF	2 x 2.2nF
"	3	2 x 2mH	1 x 47nF	2 x 2.2nF

Version 2

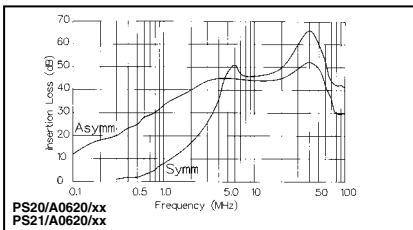
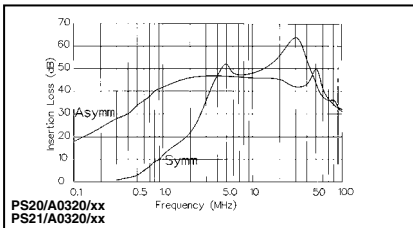

Version 3

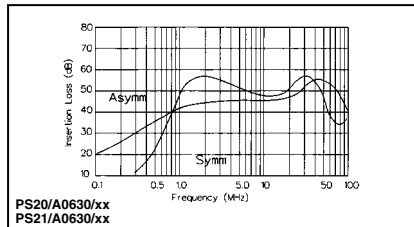
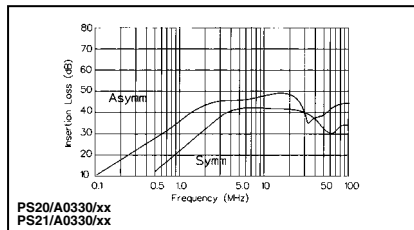
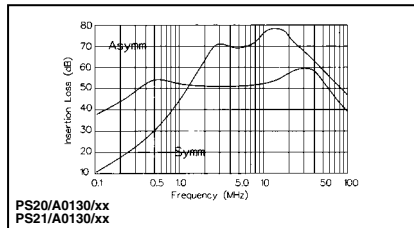

High Performance IEC Power Inlets Flange and Snap Fit (Single Fused)

PANEL MOUNTING



- 3 or 6 Amp Current Rating
- Single Fused
- High Performance
- 2.8 or 6.3mm tabs

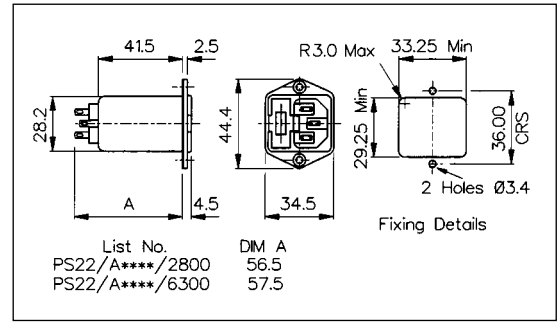

SNAP FIT

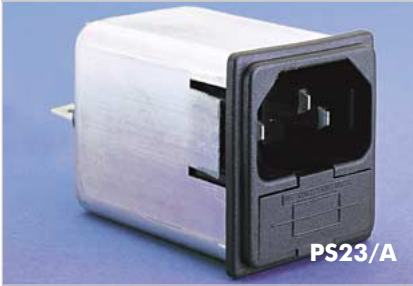

- 3 or 6 Amp Current Rating
- Single Fused
- High Performance
- 2.8 or 6.3mm tabs
- 1, 1.5, 2 or 3mm panels

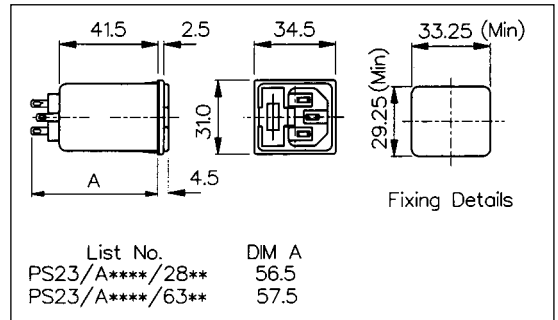

IEC CONNECTORS

PS22 or PS23/Axx xx /xx xx

Series	Rating	L/C Circuit	Additional Components	Tag Type and Configuration	Panel Thickness
PS22/A	03 = 3A	3 = Version 3	0 = None	28 = 2.8mm	Blank = Flange
PS23/A	06 = 6A			63 = 6.3mm tabs	10 = 1.0mm 15 = 1.5mm 20 = 2.0mm 30 = 3.0mm

Specification	PS22/Axxx0/xx00	PS23/Axxx0/xxxx	Part No. Example
Max. Working Voltage:	250V a.c. 50-400Hz	250V a.c. 50-400Hz	<p>PS22/A0630/63 =</p> <p>PS22 series, flange fitting, filtered IEC power inlet, single fused, rated at 6 amperes. L/C circuit version 3, i.e. L1 = 2 x 0.7mH, Cx = 1 x 47nF, Cy = 2 x 2.2nF. Without bleed resistor or surge protection device fitted, with 6.3mm tabs.</p>
Earth Leakage Current:	<0.35mA (250V, 50Hz)	<0.35mA (250V, 50Hz)	
Temperature Range:	-25°C to +85°C	-25°C to +85°C	
Max. Ambient Temp.: (@ Full Load)	40°C (derate linearly to 0A @ 85°C)	40°C (derate linearly to 0A @ 85°C)	
Test Voltage:	2700V d.c. 2 secs. Lines to Earth 1100V d.c. 2 secs. Live to Neutral	2700V d.c. 2 secs. Lines to Earth 1100V d.c. 2 secs. Live to Neutral	
Approvals:			
Mating Connectors:	PX0587, PX0587/SE, PX0588 PZ0100, PZ0200	PX0587, PX0587/SE, PX0588 PZ0100, PZ0200	
Accessories:	P.No. 14340 (see page 82)	P.No. 14340 (see page 82)	
RoHS	Compliant	Compliant	

Rating & Version Table
PS22/Axx30/xx00 & PS23/Axx30/xxxx

Rating	Version	L1	Cx	Cy
3 AMP	1			
"	2			
"	3	2 x 1.8mH	2 x 47nF	2 x 2.2nF
6 AMP	1			
"	2			
"	3	2 x 0.7mH	2 x 47nF	2 x 2.2nF

Version 3

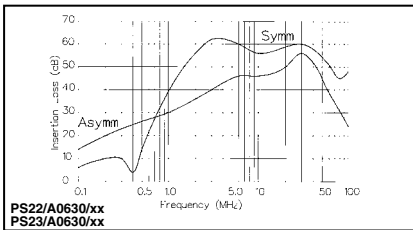
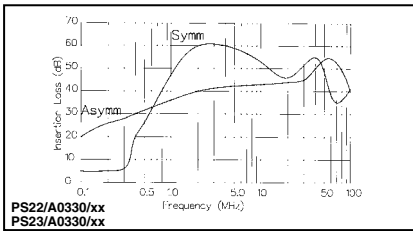

IEC Power Inlets Flange and Snap Fit (Twin Fused)

PANEL MOUNTING



- 2 or 4 Amp Current Rating
- Twin Fused
- Optional Additional Components
- 2.8 or 6.3mm tabs

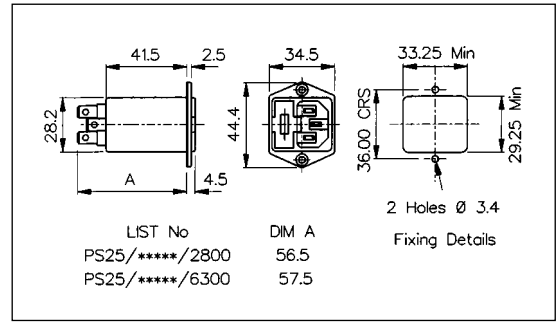

SNAP FIT



- 2 or 4 Amp Current Rating
- Twin Fused
- Optional Additional Components
- 2.8 or 6.3mm tabs
- 1, 1.5, 2 or 3mm panels

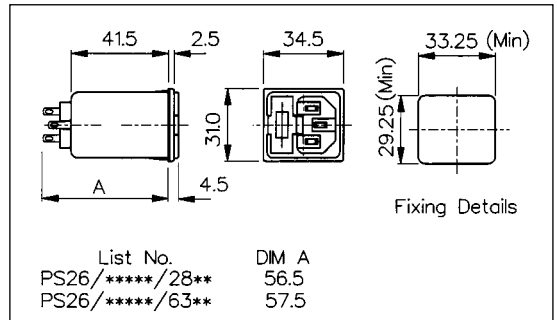

IEC CONNECTORS

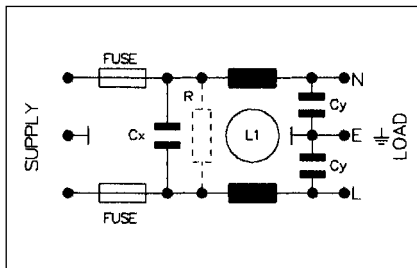

PS25 or PS26/Axx 2x / xx xx

Series	Rating	L/C Circuit	Additional Components	Tag Type and Configuration	Panel Thickness
PS25/A	02 = 2A	2 = Version 2	0 = None	28 = 2.8mm	Blank = Flange
PS26/A	04 = 4A		1 = Bleed (R) Resistor	63 = 6.3mm tabs	10 = 1.0mm 15 = 1.5mm 20 = 2.0mm 30 = 3.0mm

Specification	PS25/Axx2x/xx00	PS26/Axx2x/xxxx	Part No. Example
Max. Working Voltage:	250V a.c. 50-400Hz	250V a.c. 50-400Hz	<p>PS25/A0420/28=</p> <p>PS25 series, flange fitting, standard filtered IEC power inlet, twin fused, rated at 4 amperes. L/C circuit version 2, i.e. L1 = 2 x 0.7mH, Cx = 1 x 15nF, Cy = 2 x 2.2nF Without bleed resistor fitted, with 2.8mm tabs.</p>
Max. Power Dissipation:	2.5W per fuse	2.5W per fuse	
Earth Leakage Current:	<0.35mA (250V, 50Hz)	<0.35mA (250V, 50Hz)	
Temperature Range:	-25°C to +85°C	-25°C to +85°C	
Max. Ambient Temp.: (@ Full Load)	40°C (derate linearly to 0A @ 85°C)	40°C (derate linearly to 0A @ 85°C)	
Test Voltage:	2700V d.c. 2 secs. Lines to Earth 1100V d.c. 2 secs. Live to Neutral	2700V d.c. 2 secs. Lines to Earth 1100V d.c. 2 secs. Live to Neutral	
Approvals:			
Mating Connectors:	PX0587, PX0587/SE, PX0588 PZ0100, PZ0200	PX0587, PX0587/SE, PX0588 PZ0100, PZ0200	
Accessories:	P.No. 14340 (see page 82)	P.No. 14340 (see page 82)	
RoHS	Compliant	Compliant	

Rating & Version Table
PS25/Axx2x/xx00 & PS26/Axx2x/xxxx

Rating	Version	L1	Cx	Cy
2 AMP	1	2 x 1.8mH	1 x 15nF	2 x 2.2nF
"	2			
"	3			
4 AMP	1	2 x 0.7mH	1 x 15nF	2 x 2.2nF
"	2			
"	3			

Version 2

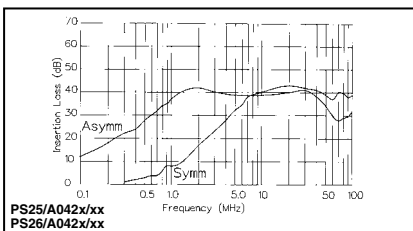
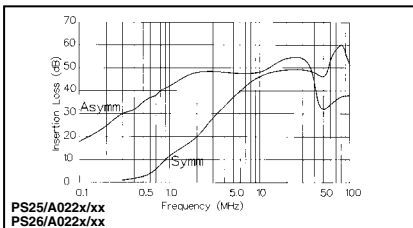

Medical IEC Power Inlets (Twin Fused)

PANEL MOUNTING



PS25/B
Flange

- 2 or 4 Amp Current Rating
- Medical
- Twin Fused
- Optional Additional Components
- 2.8 or 6.3mm tabs

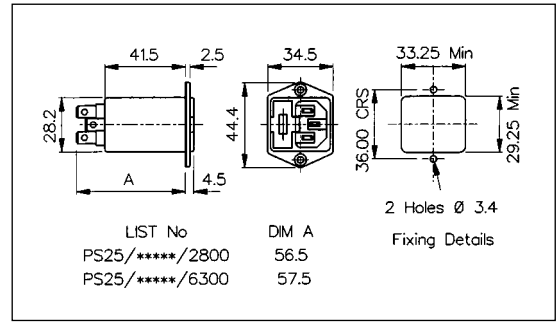

SNAP FIT



PS26/B
Snap-Fit

- 2 or 4 Amp Current Rating
- Medical
- Twin Fused
- Optional Additional Components
- 2.8 or 6.3mm tabs
- 1, 1.5, 2 or 3mm panels

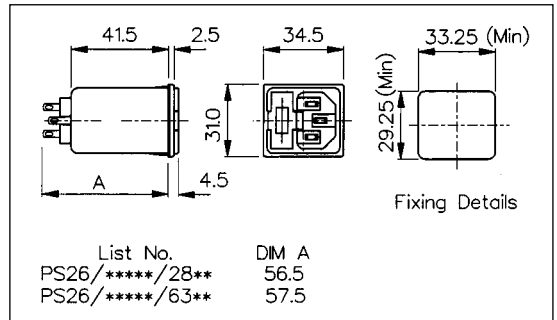

IEC CONNECTORS

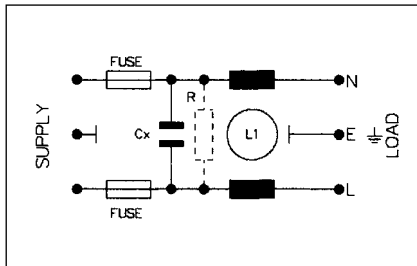

PS25 or PS26/Bxx 2x / xx xx

Series	Rating	L/C Circuit	Additional Components	Tag Type and Configuration	Panel Thickness
PS25/B	02 = 2A	2 = Version 2	0 = None	28 = 2.8mm	Blank = Flange
PS26/B	04 = 4A		1 = Bleed (R) Resistor	63 = 6.3mm tabs	10 = 1.0mm 15 = 1.5mm 20 = 2.0mm 30 = 3.0mm

Specification	PS25/Bxx2x/xx00	PS26/Bxx2x/xxxx	Part No. Example
Max. Working Voltage:	250V a.c. 50-400Hz	250V a.c. 50-400Hz	<div style="border: 1px solid black; padding: 5px;"> <p>PS25/B0220/63 =</p> <p>PS25 series, flange fitting, for medical applications, rated at 2 amperes. L/C circuit version 2, i.e L1 = 2 x 1.8mH, Cx = 1 x 15nF, without bleed resistor fitted, with 6.3mm tabs.</p> </div>
Max. Power Dissipation:	2.5W per fuse	2.5W per fuse	
Earth Leakage Current:	<100µA (typically 5µA 250V, 50Hz)	<100µA (typically 5µA 250V, 50Hz)	
Temperature Range:	-25°C to +85°C	-25°C to +85°C	
Max. Ambient Temp.: (@ Full Load)	40°C (derate linearly to 0A @ 85°C)	40°C (derate linearly to 0A @ 85°C)	
Test Voltage:	2700V d.c. 2 secs. Lines to Earth 1100V d.c. 2 secs. Live to Neutral	2700V d.c. 2 secs. Lines to Earth 1100V d.c. 2 secs. Live to Neutral	
Approvals:			
Mating Connectors:	PX0587, PX0587/SE, PX0588 PZ0100, PZ0200	PX0587, PX0587/SE, PX0588 PZ0100, PZ0200	
Accessories:	P.No. 14340 (see page 82)	P.No. 14340 (see page 82)	
RoHS	Compliant	Compliant	

Rating & Version Table
PS25/Bxx2x/xx00 & PS26/Bxx2x/xxxx

Rating	Version	L1	Cx
2 AMP	1	2 x 1.8mH	1 x 15nF
"	2		
"	3		
4 AMP	1	2 x 0.7mH	1 x 15nF
"	2		
"	3		

Version 2

