



Circular Data Connectors

A full range of **IP68** rated environmentally **sealed circular connectors** designed to provide secure and safe connections in harsh or hostile conditions.

The Data Buccaneer range now includes designs specifically for Ethernet, USB and SMB applications. Ethernet Buccaneer meets Cat 5e requirements for data rates up to 100Mbps, USB Buccaneer is designed to meet USB version 2.0 specification for data rates up to 480Mbps, SMB Buccaneer has a frequency response up to 4GHz.

The Buccaneer series finds numerous applications either in external or internal environments where protection against the ingress of dust and moisture is a system requirement.





- ⊗ IP68 when mated, Tested in accordance with EN60529:1992+A2:2013
- ⊗ IP69K when mated, Tested in accordance with DIN 40050/Part 9 IP69k
- ⊗ EN60068-2-52 Test Kb Salt Mist (Cyclic) Marine Severity Level 1
- ⊗ Secure, proven & reliable screw locking mechanism
- ⊗ PUR / PVC Jacket on cable
- ⊗ Chemical resistance & flame retardant
- ⊗ Cat 8 toolless Keystone IDC connector
- ⊗ Data rates up to 25Gbps
- ⊗ Backwards compatibility throughout
- ⊗ Cat 5e or Cat 6a Shielded coupler
- ⊗ Rewireable Flex connector up to Cat 6a
- ⊗ Field termination up to Cat 6a
- ⊗ Earth lead version of panel mounting coupler
- ⊗ Cat 5e PCB Mount & IDC termination panel connector
- ⊗ High noise immunity, full shielding and EMI protection
- ⊗ Power over Ethernet (PoE) compliant

Patch Cord Flex Connector



PX0836

- Mates with all panel mounting connectors
- Patchcords with IP68 connector
- Supplied with shielded RJ45 plug
- Single or double end terminated
- Standard lengths: 2m, 3m & 5m
- S-FTP cable construction
- PUR (Cat 5e) or PVC (Cat 6a / 8) jacket cable
- Wiring configuration to 568-B

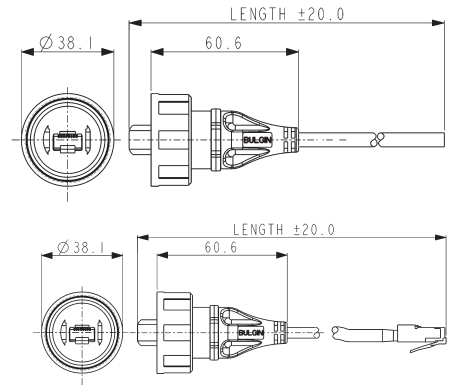

Part no.	Type	Length	Description
PX0836/2M00	Wire end	2m	Cat 5e IP68 RJ45 Buccaneer to bare end
PX0836/3M00	Wire end	3m	Cat 5e IP68 RJ45 Buccaneer to bare end
PX0836/5M00	Wire end	5m	Cat 5e IP68 RJ45 Buccaneer to bare end
PX0837/2M00	Single ended	2m	Cat 5e IP68 RJ45 Buccaneer to Shielded RJ45
PX0837/3M00	Single ended	3m	Cat 5e IP68 RJ45 Buccaneer to Shielded RJ45
PX0837/5M00	Single ended	5m	Cat 5e IP68 RJ45 Buccaneer to Shielded RJ45
PX0838/2M00	Double ended	2m	Cat 5e IP68 RJ45 Buccaneer to IP68 RJ45 Buccaneer
PX0838/3M00	Double ended	3m	Cat 5e IP68 RJ45 Buccaneer to IP68 RJ45 Buccaneer
PX0838/5M00	Double ended	5m	Cat 5e IP68 RJ45 Buccaneer to IP68 RJ45 Buccaneer
PX0896/2M00	Wire end	2m	Cat 6a IP68 RJ45 Buccaneer to bare end
PX0896/3M00	Wire end	3m	Cat 6a IP68 RJ45 Buccaneer to bare end
PX0896/5M00	Wire end	5m	Cat 6a IP68 RJ45 Buccaneer to bare end
PX0897/2M00	Single ended	2m	Cat 6a IP68 RJ45 Buccaneer to Shielded RJ45
PX0897/3M00	Single ended	3m	Cat 6a IP68 RJ45 Buccaneer to Shielded RJ45
PX0897/5M00	Single ended	5m	Cat 6a IP68 RJ45 Buccaneer to Shielded RJ45
PX0898/2M00	Double ended	2m	Cat 6a IP68 RJ45 Buccaneer to IP68 RJ45 Buccaneer
PX0898/3M00	Double ended	3m	Cat 6a IP68 RJ45 Buccaneer to IP68 RJ45 Buccaneer
PX0898/5M00	Double ended	5m	Cat 6a IP68 RJ45 Buccaneer to IP68 RJ45 Buccaneer
PX0857/2M00	Single ended	2m	Cat 8 IP68 RJ45 Buccaneer to IP68 Shielded RJ45
PX0857/3M00	Single ended	3m	Cat 8 IP68 RJ45 Buccaneer to IP68 Shielded RJ45
PX0857/5M00	Single ended	5m	Cat 8 IP68 RJ45 Buccaneer to IP68 Shielded RJ45
PX0858/2M00	Double ended	2m	Cat 8 IP68 RJ45 Buccaneer to IP68 RJ45 Buccaneer
PX0858/3M00	Double ended	3m	Cat 8 IP68 RJ45 Buccaneer to IP68 RJ45 Buccaneer
PX0858/5M00	Double ended	5m	Cat 8 IP68 RJ45 Buccaneer to IP68 RJ45 Buccaneer

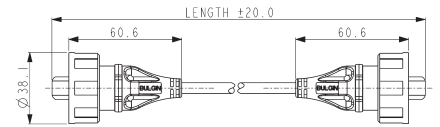

Re Wireable Flex Connector



PX0834

- Mates with all panel mounting connectors
- Supplied with shielded RJ45 plug
- Two versions:
 - Cat 5e or Cat 6a Cable size from 5 to 6mm diameter, or extra cable glands for other cable sizes from 3.5 to 8mm diameter.

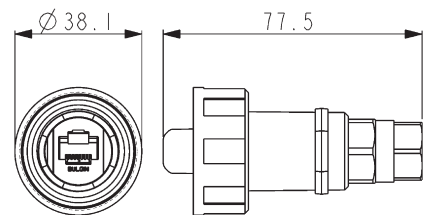

Part no.	Description
PX0834/A	Cat 5e suitable for use with cables from 5 to 6mm diameter
PX0834/B	Cat 5e with 2 extra cable glands, suitable for use with cables from 3.5 to 8mm diameter
PX0894/A	Cat 6a suitable for use with cables from 5 to 6mm diameter
PX0894/B	Cat 6a with 2 extra cable glands, suitable for use with cables from 3.5 to 8mm diameter

Front Panel Mounting Coupler Connector



PX0833

- Cat 5e mates with PX0836, PX0837, PX0838 & PX0834 flex connectors
- Cat 6a mates with PX0896, PX0897, PX0898 & PX0894 flex connectors
- Standard RJ45 patchcord can be plugged into rear
- Version with earth wire available
- Single hole fixing
- Complete with panel sealing gasket

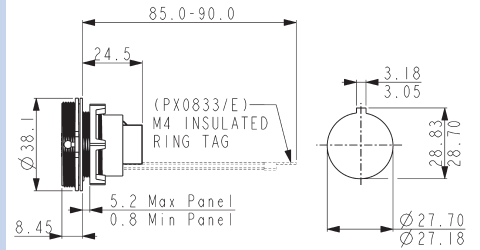

Part no.	Description	Fixing
PX0833	Cat 5e coupler	Front panel mounted
PX0833/E	Cat 5e coupler + earth wire	Front panel mounted
PX0893	Cat 6a coupler	Front panel mounted
PX0893/E	Cat 6a coupler + earth wire	Front panel mounted

Front Panel Mounting Keystone Connector



PX0855/KS

- Backwards compatible with all flex connectors
- Cat 8 mates with PX0857, PX0858 flex connectors
- Toolless jack termination
- Maintains shielding ground continuity
- Single hole fixing
- Complete with panel sealing gasket

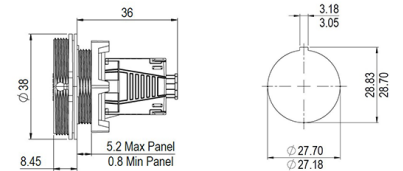

Part no.	Description	Fixing
PX0855/KS	Cat 8 Keystone connector	Front panel mounted

Rear Panel Mounting Keystone Connector



PX0856/KS

- Backwards compatible with all flex connectors
- Cat 8 mates with PX0857, PX0858 flex connectors
- Toolless jack termination
- Maintains shielding ground continuity
- Single hole fixing
- Complete with panel sealing gasket

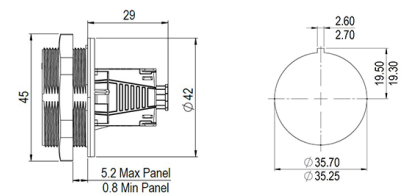

Part no.	Description	Fixing
PX0856/KS	Cat 8 Keystone connector	Rear panel mounted

Flange Mounting Connector



PX0870

- Cat 5e mates with PX0836, PX0837, PX0838 & PX0834 flex connectors
- Cat 6a mates with PX0896, PX0897, PX0898 & PX0894 flex connectors
- Standard RJ45 patchcord can be plugged into rear
- Version with earth wire available
- Flange fixing
- Complete with panel sealing gasket

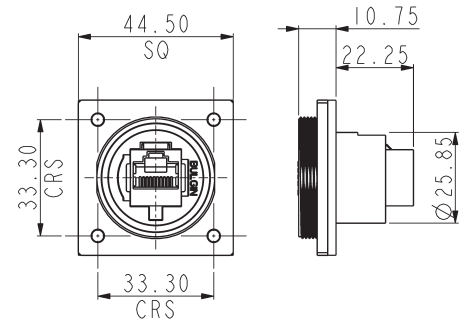

Part no.	Description	Fixing
PX0870	Cat 5e coupler	Flange mounting
PX0870/E	Cat 5e coupler + earth wire	Flange mounting
PX0890	Cat 6a coupler	Flange mounting
PX0890/E	Cat 6a coupler + earth wire	Flange mounting

PCB Mounting Connector



PX0839/PC

- Cat 5e shielded RJ45 interface
- Rear of panel mounted
- Mates with PX0836, PX0837, PX0838 and PX0834 flex connectors
- For direct vertical mounting to PCB, straight Plugs
- Complete with panel sealing PX0839/PC gasket

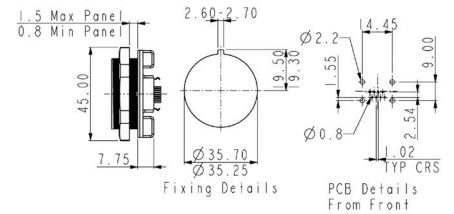

Part no.	Description	Fixing
PX0839/PC	Cat 5e connector - PC	Rear panel mounted

PCB Mounting Connector



PX0839/90

- Cat 5e shielded RJ45 interface
- Rear of panel mounted
- Mates with PX0836, PX0837, PX0838 and PX0834 flex connectors
- For direct horizontal mounting to PCB, 90° Plugs
- Complete with panel sealing PX0839/90 gasket

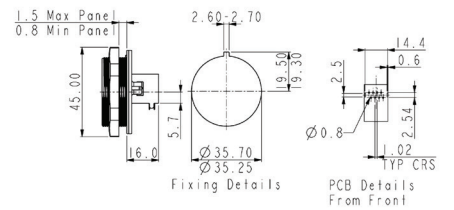

Part no.	Description	Fixing
PX0839/90	Cat 5e connector - 90 degree Plugs	Rear panel mounted

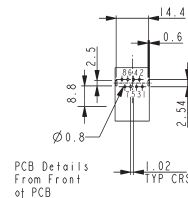

Panel Mounting Connector



PX0839/IDC

- Cat 5e shielded RJ45 interface
- Rear of panel mounted
- Mates with PX0836, PX0837, PX0838 and PX0834 flex connectors
- Two IDC blocks for discrete termination
- Complete with panel sealing

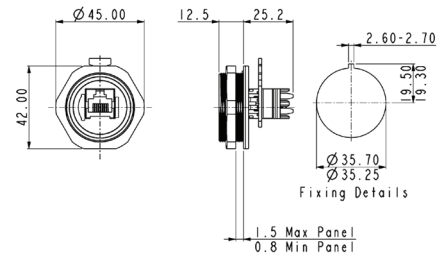

Part no.	Description	Fixing
PX0839/IDC	Cat 5e coupler - IDC	Rear panel mounted

Shield Back Shell Accessory



PX0888

- Maintains RJ45 coupler screening directly to panel
- Shielding can is fixed to rear of panel mount connector
- For use on PX0833, PX0893 & PX0855

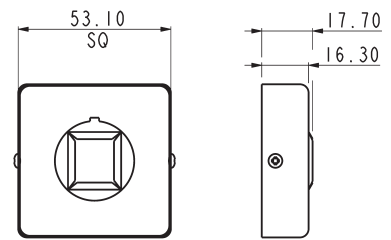

Part no.	Description
PX0888	Shielding backshell accessory

Accessories



Sealing Caps

- Sealing caps to maintain IP68 rating when connectors are not in use
- Replacement shielded RJ45s
- Hand crimp tool for shielded RJ45
- Patch cord cable available in 50m reels

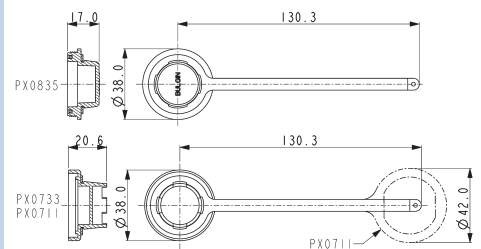

Part no.	Description
PX0835	Sealing Cap for use on all ethernet flex connectors
PX0733	Sealing Cap for use on all front panel mounting connectors
PX0711	Sealing Cap for use on all rear panel mounting connectors
14151	Cat 5e & Cat 6a Hand crimp tooling + die set
14199	Cat 5e PUR Jacket Cable - 50m reel
14150	Cat 5e Replacement shielded RJ45
15241	Cat 6a PVC Jacket Cable - 50m reel

Connectors	Cat 5e & 6a	Cat 8
Sealing:	IP68, EN60529:1992+A2:2013 (10m depth for 2 weeks)	IP68, EN60529:1992+A2:2013 (10m depth for 2 weeks)
	IP69K, Tested in accordance with DIN 40050/Part 9 IP6k9k	IP69K, Tested in accordance with DIN 40050/Part 9 IP6k9k
Operating Temperature:	-20°C to +70°C	-20°C to +60°C
Materials - Overmoulded		
Overmould material:	PVC (black)	Polyamide (black)
Flammability rating:	UL94V-0	UL94V-0
Salt Mist:	EN60068-2-52 Test Kb Salt Mist (Cyclic) Marine Severity Level 1	EN60068-2-52 Test Kb Salt Mist (Cyclic) Marine Severity Level 1

Materials - Re-wireable and Panel Connectors

Connector body & locking ring	Polyester
Panel connector	Nylon 6
Flammability rating	UL94V-0
'O' rings	Silicone
Panel Gasket - round	Silicone
Panel Gasket - flange	Neoprene
RoHS	Compliant

Cables & POE	Cat 5e	Cat 6a	Cat 8
Conductors	24AWG (7/0.2mm) bare copper	26AWG (7/0.16mm) bare copper	26AWG (7/0.16mm) bare copper
Insulation	HD-PE	PE (Skin - Foam - Skin)	N/A
Pair	2 of the above cores twisted	2 of the above cores twisted	2 of the above cores twisted
Core	4 of the above cores	4 of the above cores	4 of the above cores
Screen	1 layer mylar and aluminium tape,	Aluminium & Polyester	Aluminium & Polyester
Braid	0.12mm tinned copper braid	Tinned Copper Braid	Tinned Copper Braid
Jacket	PUR (Black)	PVC (Black)	PVC (Black)
Op Temperature	-25°C to +85°C	-25°C to +75°C	-20°C to +60°C
Diameter	6.1mm nominal	6.0 mm nominal	6.0 mm nominal
Flame Test		FT4	
Electrical @ 20°C			
Characteristic:			
Impedance	100 Ω \pm 15 Ω @ 100MHz		
Capacitance	330pF/km		
Conductor Loop			
Resistance	29/ Ω 100m maximum	26 Ω /km	
Skew	45 nsec/100m @ 100MHz		
PoE Standard:	IEEE 802.3af (2 pair)	IEEE 802.3bt, Type 4 (4 pair) 4PoE++	IEEE 802.3bt, Type 4 (4 pair) 4PoE++
Power rating	12.95W	71W	71W
Current rating	350mA	960mA	1500mA
Voltage rating (DC)	44-57V	41.1V-57V	72V
Mechanical Characteristics			
Minimum Tensile Strength of Jacket (kgf/mm ²)		1.05	
Maximum Length for Strip of Jacket (mm)		40	

Cable construction - CAT 5e

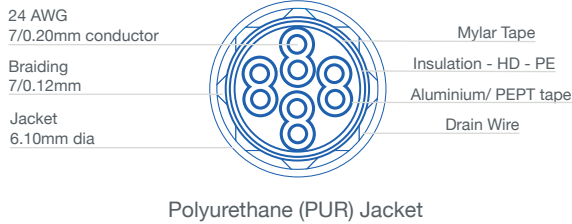

Cable construction - Cat 6a & Cat 8

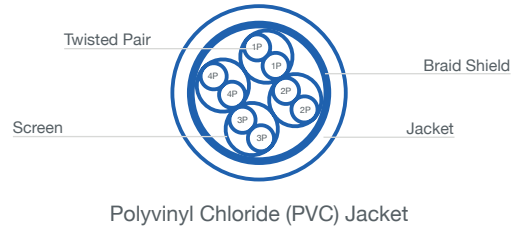

RJ45 Plug

Cat 5e & PoE

Cat 6a

Cat 8

Materials

Moulding	Polycarbonate	Polycarbonate	Polycarbonate
Shielding			Zinc Alloy
Flammability	UL94V-0	UL94V-0	UL94V-2
Contact material	Phosphor Bronze	Phosphor Bronze	Phosphor Bronze
Contact plating	50-micron gold	50-micron gold	50-micron gold
Operating Temperature	-40°C to +70°C	-40°C to +70°C	-20°C to +60°C
Mating cycles	1,000 cycles	1,000 cycles	1,200 cycles
RoHS	Compliant	Compliant	Compliant

Electrical

No. Conductors	8	8	8
Conductor types	24-28AWG, solid or multistranded	24-28AWG, solid or multistranded	26AWG, multistranded (pre-terminated)
Current rating	350mA	1500mA	1500mA
Voltage rating	37V AC, 57V DC	30V AC, 42V DC	72V DC
Contact resistance	10mΩ	10mΩ	20mΩ max.

Cat 8 (Keystone)

Materials

Coupler Shell	Zinc
Coupler Plating	Nickel
Moulding	PC
IDC Housing	PC
IDC Cap	PC + glass fibre
IDC Terminal	Tin plated Phosphor Bronze
Ground Contact	Stainless steel, Copper foil
Tie wrap	Nylon 6/6
Flammability	UL94V-2
Contact material	Phosphor Bronze
Contact plating	50-micron gold
Operating Temperature	-10°C to +60°C
Mating cycles - Jack	>750 cycles
Mating cycles - IDC	>20 terminations
RoHS	Compliant

Electrical

No. Conductors	8
Current rating	1.5A
Voltage rating	100V DC
Dielectric Withstand	1000V DC/AC @ 60hz for 1 minute
Contact resistance	10mΩ max.

RJ45 Coupler	Cat 5e	Cat 6a
Materials		
Coupler Shell	Copper Alloy	Copper Alloy
Coupler Plating	Nickel	Nickel
Moulding	PBT	PBT
Flammability	UL94V-0	UL94V-0
Contact material	Phosphor Bronze	Phosphor Bronze
Contact plating	50 micron gold	50 micron gold
Operating Temperature	-40°C to +70°C	0°C to +70°C
Mating cycles	1,000 cycles	1,000 cycles
RoHS	Compliant	Compliant
Electrical		
No. Conductors	8	8
Current rating	1.5A	1.5A
Voltage rating	30V AC, 42V DC	30V AC, 42V DC
Contact resistance	10mΩ max.	10mΩ max.

RJ45 PCB Connector	Cat 5e
Materials	
Coupler Shell	Copper Alloy
Coupler Plating	Nickel
Moulding	PBT
Flammability	UL94V-0
Contact material	Phosphor Bronze
Contact plating	50 micron gold
PC Plugs	Tin plated
Operating Temperature	-40°C to +70°C
Mating cycles	1,000 cycles
RoHS	Compliant
Electrical	
No. Conductors	8
Current rating	1.5A
Voltage rating	30V AC, 42V DC
Contact resistance	10mΩ max.

Cable Joiner



PX0777

- IP68 Rating
- For Sealed Inline RJ45 Connections
- Supplied Complete with Coupler
- Shielded (STP) & Unshielded (UTP) versions
- Cat5e Shielded Coupler also available
- Cable Range 3.5 - 8mm (with glands supplied)

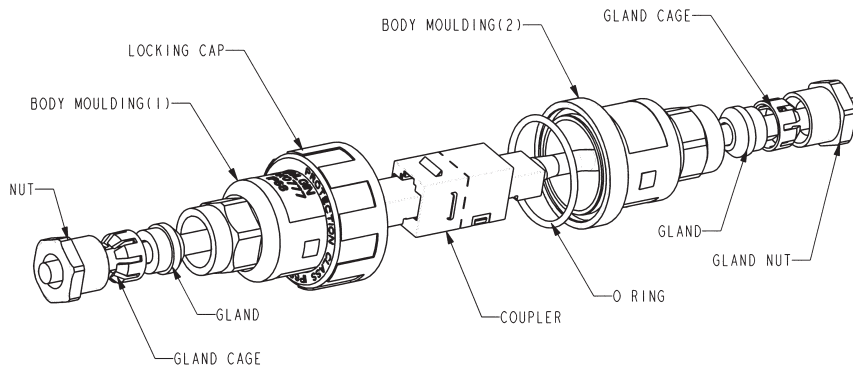
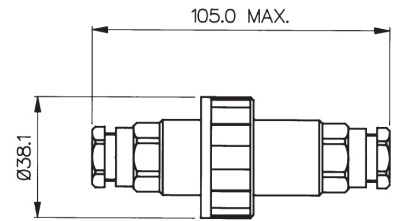

Specifications	PX0777/UTP	PX0777/STP	PX0777/CAT5ESTP	PX0777/CAT6ASTP
Rating:	1.5A, 30V AC, 42V DC	1.5A, 30V AC, 42V DC	1.5A, 30V AC, 42V DC	1.5A, 30V AC, 42V DC
No. of Conductors:	8	8	8	8
Coupler Type:	Unshielded	Shielded	Shielded CAT5e performance	Shielded CAT6a performance
Cable Range:	3.5 - 8mm With glands supplied: 3.5 - 5mm (Blue) 5 - 7mm (Green) 6 - 8mm (Red)	3.5 - 8mm With glands supplied: 3.5 - 5mm (Blue) 5 - 7mm (Green) 6 - 8mm (Red)	3.5 - 8mm With glands supplied: 3.5 - 5mm (Blue) 5 - 7mm (Green) 6 - 8mm (Red)	3.5 - 8mm With glands supplied: 3.5 - 5mm (Blue) 5 - 7mm (Green) 6 - 8mm (Red)
Material:	Glass Filled Polyamide UL94V-0	Glass Filled Polyamide UL94V0	Glass Filled Polyamide UL94V0	Glass Filled Polyamide UL94V0
Sealing:	IP68 to BSEN 60529:1992+A2:2013 (10m depth for 2 weeks)	IP68 to BSEN 60529:1992+A2:2013 (10m depth for 2 weeks)	IP68 to BSEN 60529:1992+A2:2013 (10m depth for 2 weeks)	IP68 to BSEN 60529:1992+A2:2013 (10m depth for 2 weeks)
Salt Mist	EN60068-2-52 Test Kb Salt Mist (Cyclic) Marine Severity Level 1	EN60068-2-52 Test Kb Salt Mist (Cyclic) Marine Severity Level 1	EN60068-2-52 Test Kb Salt Mist (Cyclic) Marine Severity Level 1	EN60068-2-52 Test Kb Salt Mist (Cyclic) Marine Severity Level 1
Operating Temp Range:	-20°C to +70°C	-20°C to +70°C	-20°C to +70°C	-20°C to +70°C
Colour:	Black	Black	Black	Black
RoHS	Compliant	Compliant	Compliant	Compliant



- ⊕ IP68 when mated, Tested in accordance with EN60529:1992+A2:2013
- ⊕ IP69K when mated, Tested in accordance with DIN 40050/Part 9 IP69k
- ⊕ EN60068-2-52 Test Kb Salt Mist (Cyclic) Marine Severity Level 1
- ⊕ HDMI 2.1 Performance
- ⊕ Shielded system
- ⊕ Single and double ended cables
- ⊕ Screw coupling
- ⊕ Resolutions and refresh rates of 8K at 60Hz and 4K at 120Hz
- ⊕ Hot pluggable, standard 19 contact interface
- ⊕ Alignment indicator reduces risk of damage during mating
- ⊕ High noise immunity and EMI protection
- ⊕ Secure, proven locking system
- ⊕ Direct mounting or via adaptor leads
- ⊕ Plug and play capability

Sealed HDMI Cables - Single Ended



PX0867

- Single ended sealed cable assembly
- IP68 HDMI connector to standard HDMI connector
- Mates with all panel mount connectors
- Available in 2m, 3m & 5m lengths

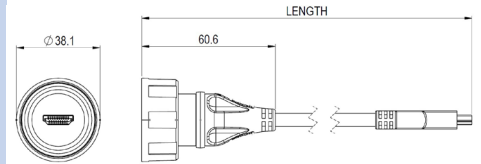

Part no.	Length	Description
PX0867/2M00	2m	IP68 HDMI male to standard HDMI male
PX0867/3M00	3m	IP68 HDMI male to standard HDMI male
PX0867/5M00	5m	IP68 HDMI male to standard HDMI male

Sealed HDMI Cables - Double Ended



PX0868

- Double ended sealed cable assembly
- IP68 HDMI connector to IP68 HDMI connector
- Mates with all panel mount connectors
- Available in 2m, 3m & 5m lengths

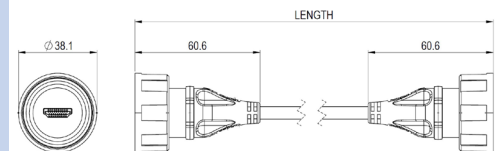

Part no.	Length	Description
PX0868/2M00	2m	IP68 HDMI male to IP68 HDMI male
PX0868/3M00	3m	IP68 HDMI male to IP68 HDMI male
PX0868/5M00	5m	IP68 HDMI male to IP68 HDMI male

Front Panel Mounting Connector



PX0863

- PX0863 – HDMI IP68 connector
- Female HDMI connector at rear of panel
- Mates with PX0867 and PX0868 cable connectors

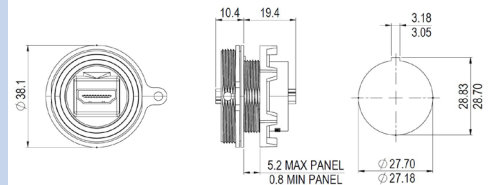

Part no.	Description
PX0863	IP68 HDMI female, front panel mounted. Sealed HDMI at front of panel, standard HDMI type at rear

Front Panel Mounting Connector



PX0863/1M00

- PX0863/1M00 – HDMI IP68 connector with 1m HDMI male lead at rear of panel
- Mates with PX0867 and PX0868 cable connectors

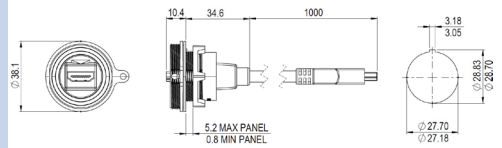

Part no.	Length	Description
PX0863/1M00	1m	IP68 HDMI female with 1m lead, front panel mounted, sealed HDMI at front of panel, standard HDMI at rear

Rear Panel Mounting Connector



PX0869

- PX0869 – HDMI IP68 connector
- Female HDMI connector at rear of panel
- Mates with PX0867 and PX0868 cable connectors

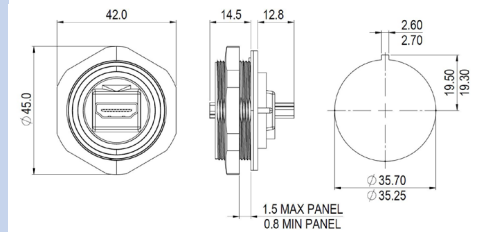

Part no.	Description
PX0869	IP68 HDMI female, rear panel mounted, sealed HDMI at front of panel, standard HDMI type at rear

Rear Panel Mounting Connector



PX0869/1M00

- PX0869/1M00 – HDMI IP68 connector with 1m HDMI male lead at rear of panel
- Mates with PX0867 and PX0868 cable connectors

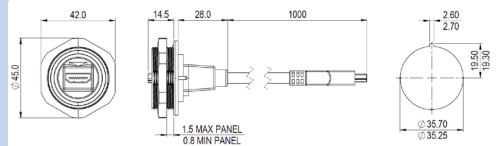

Part no.	Length	Description
PX0869/1M00	1m	IP68 HDMI female, with 1m lead, rear panel mounted, sealed HDMI at front of panel, standard HDMI at rear

Accessories



Sealing Caps

- Sealing caps to maintain IP68 rating when connectors are not in use
- PX0835 for cable connectors PX0867 & PX0868
- PX0733 for front panel mount connectors PX0863, PX0863/1M00
- PX0711 for rear panel mount connectors PX0869, PX0869/1M00

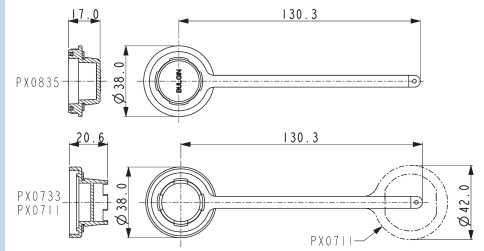

Part no.	Description
PX0835	Sealing Cap for cable connectors (PX0867, PX0868)
PX0733	Sealing Cap for front panel mounting connector (PX0863, PX0863/1M00)
PX0711	Sealing Cap for rear panel mounting connector (PX0869, PX0869/1M00)

Cables & connectors

Mechanical	IP68, EN60529:1992+A2:2013 (10m depth for 2 weeks)
Sealing	IP69K, Tested in accordance with DIN 40050/Part 9 IP6k9k
Operating temperature	-25°C to +80°C
Salt Mist	EN60068-2-52 Test Kb Salt Mist (Cyclic) Marine Severity Level 1
Electrical	
No. of Contacts	19
Current rating	0.5A
Voltage rating	30V AC (RMS)
Contact resistance	40m Ω max.
Withstanding Voltage	500V AC RMS
Performance	Ultra High Speed HDMI™ Cable with Ethernet

Materials - Overmoulded

Overmould material	PVC (black)
Flammability rating	UL94V-0

Materials - Re-wireable and Panel Connectors

Shell material	Steel
Shell plating	Nickel
Contact material	Brass
Contact plating	Tin & Gold
Connector body & locking ring	Glass Loaded Polyester
Panel connector	Acetal
Flammability rating	UL94 HB
'O' rings	Silicone
Panel Gasket - round	Silicone
Panel Gasket - square	Neoprene
Mating cycles	1,000
RoHS	Compliant

Materials - cable

Cable Jacket	PVC (black)
Braid	Aluminium-Magnesium Alloy
Screen Foil	Aluminium Foil
Insulation	HDPE and F-PE
Drain Wire	Tin-Copper Alloy
Flammability Rating	UL94V-0

Length:	Dia	Conductors Signal	Conductors Power
2m	6.0mm	4 x 30AWG	5 x 30AWG
3m	6.0mm	4 x 30AWG	5 x 30AWG
5m	7.3mm	1 x 28AWG 3 x 30AWG	4 x 28AWG 1 x 32AWG

Cable construction - PX0867, PX0868

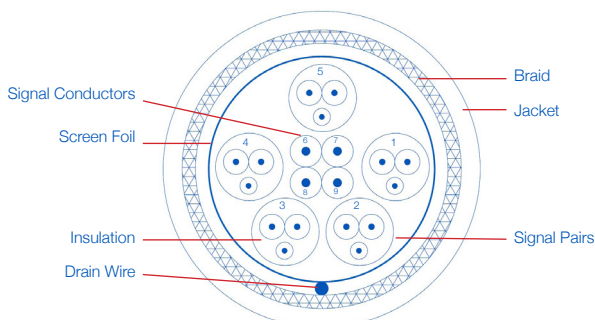



- IP68 when mated, tested in accordance with EN60529:1992+A2:2013
- IP69K when mated, tested in accordance with DIN 40050/Part 9 IP6k9k
- EN60068-2-52 Test Kb Salt Mist (Cyclic) Marine Severity Level 1
- USB version 2.0 and 3.0 performance
- Shielded system
- Single and double ended cables
- Screw coupling
- PCB mounted panel connector
- High-speed bus connection, USB 2.0: up to 480Mbps
USB 3.0: up to 5Gbps
- Hot pluggable, USB 2.0 with 4 contact interface, USB 3.0 with 9 contact interface
- Alignment indicator reduces risk of damage during mating
- High noise immunity and EMI protection
- Suitable for PC and peripheral configuration
- Secure, proven locking system
- Direct mounting or via adaptor leads
- Plug and play capability

Sealed USB Cables - Single Ended



PX0840/A



PX0840/B



PX0840/AA

- Single ended sealed cable assembly
- IP68 'A' type USB 2.0 connector to standard 'A' or 'B' type USB 2.0 connector
- IP68 'B' type USB 2.0 connector to standard 'A' type USB 2.0 connector
- IP68 'A' type USB 3.0 connector to standard USB 3.0 'A' type connector
- Mates with all panel mount connectors
- USB 2.0 variants available in 2m, 3m & 5m lengths
- USB 3.0 variants available in 1m, 2m & 3m lengths

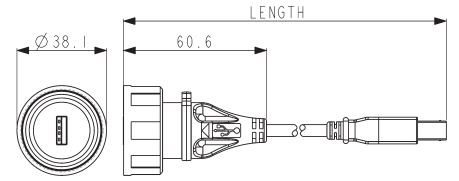

PX0840/A/xMxx

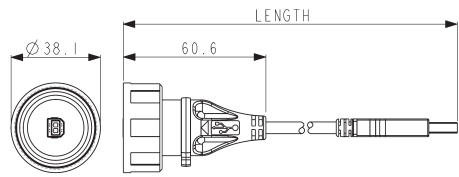

PX0840/B/xMxx

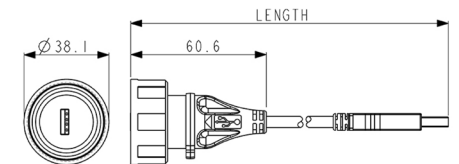

PX0840/AA/xMxx

Part no.	Length	Description
PX0840/A/2M00	2m	IP68 A type USB 2.0 to standard B type USB 2.0
PX0840/A/3M00	3m	IP68 A type USB 2.0 to standard B type USB 2.0
PX0840/A/5M00	5m	IP68 A type USB 2.0 to standard B type USB 2.0
PX0840/B/2M00	2m	IP68 B type USB 2.0 to standard A type USB 2.0
PX0840/B/3M00	3m	IP68 B type USB 2.0 to standard A type USB 2.0
PX0840/B/5M00	5m	IP68 B type USB 2.0 to standard A type USB 2.0
PX0840/AA/2M00	2m	IP68 A type USB 2.0 to standard A type USB 2.0
PX0840/AA/3M00	3m	IP68 A type USB 2.0 to standard A type USB 2.0
PX0840/AA/5M00	5m	IP68 A type USB 2.0 to standard A type USB 2.0
PX0840/A3/1M00	1m	IP68 A type USB 3.0 to standard A type USB 3.0
PX0840/A3/2M00	2m	IP68 A type USB 3.0 to standard A type USB 3.0
PX0840/A3/3M00	3m	IP68 A type USB 3.0 to standard A type USB 3.0

Sealed USB Cables Double Ended



PX0841/AA



PX0841/AB

- Double ended sealed cable assembly
- IP68 'A' type USB 2.0 connector to IP68 'A' or 'B' type USB 2.0 connector
- IP68 'A' type USB 3.0 connector to IP68 'A' type USB 3.0 connector
- Mates with all panel mount connectors
- USB 2.0 variants available in 2m, 3m & 5m lengths
- USB 3.0 variants available in 1m, 2m & 5m lengths

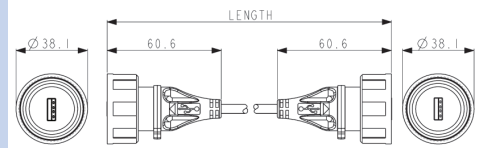

PX0841/AA/xMxx

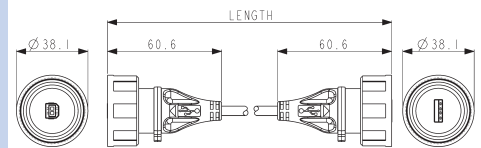

PX0841/AB/xMxx

Part no.	Length	Description
PX0841/AB/2M00	2m	IP68 A type USB 2.0 to IP68 B type USB 2.0
PX0841/AB/3M00	3m	IP68 A type USB 2.0 to IP68 B type USB 2.0
PX0841/AB/5M00	5m	IP68 A type USB 2.0 to IP68 B type USB 2.0
PX0841/AA/2M00	2m	IP68 A type USB 2.0 to IP68 A type USB 2.0
PX0841/AA/3M00	3m	IP68 A type USB 2.0 to IP68 A type USB 2.0
PX0841/AA/5M00	5m	IP68 A type USB 2.0 to IP68 A type USB 2.0
PX0841/A3/1M00	1m	IP68 A type USB 3.0 to IP68 A type USB 3.0
PX0841/A3/2M00	2m	IP68 A type USB 3.0 to IP68 A type USB 3.0
PX0841/A3/3M00	3m	IP68 A type USB 3.0 to IP68 A type USB 3.0

Front Panel Mounting Connector



PX0842/A

PX0842/B

- PX0842/A – USB 2.0 'A' type IP68 to USB 2.0 'B' type connector
- PX0842/AA – USB 2.0 'A' type IP68 to USB 2.0 'A' type connector
- PX0842/A3 – USB 3.0 'A' type IP68 to USB 3.0 'A' type connector
- PX0842/B – USB 2.0 'B' type IP68 to USB 2.0 'A' type connector
- Mates with PX0840 and PX0841 cable connectors

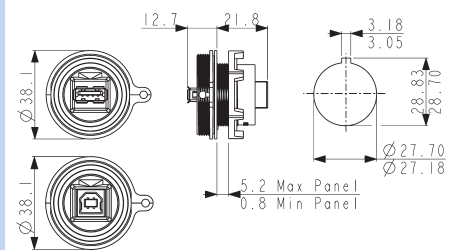

Part no.	Description
PX0842/A	IP68 A type USB 2.0, front panel mounted. Sealed A type at front of panel, standard B type at rear
PX0842/B	IP68 B type USB 2.0, front panel mounted. Sealed B type at front of panel, standard A type at rear
PX0842/AA	IP68 A type USB 2.0, front panel mounted. Sealed A type at front of panel, standard A type at rear
PX0842/A3	IP68 A type USB 3.0, front panel mounted. Sealed A type at front of panel, standard A type at rear

Front Panel Mounting Connector



PX0843/A

PX0843/B

- PX0843/A – USB 2.0 'A' type IP68 connector with 5-way crimp connector
- PX0843/B – USB 2.0 'B' type IP68 connector with 5-way crimp connector
- PX0843/A3 – USB 3.0 'A' type IP68 connector with 10-way crimp connector
- Mates with PX0840 and PX0841 cable connectors

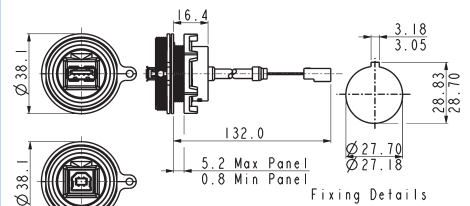

Part no.

Description

PX0843/A	IP68 A type USB 2.0, front panel mounted. Sealed A type at front of panel, 5 way crimp connector at rear.
PX0843/B	IP68 B type USB 2.0, front panel mounted. Sealed B type at front of panel, 5 way crimp connector at rear.
PX0843/A3	IP68 A type USB 3.0, front panel mounted. Sealed A type at front of panel, 10-way crimp connector at rear.
PX0460/A	As PX0843/A with exposed braid for use with PX0465 screening can
PX0460/B	As PX0843/B with exposed braid for use with PX0465 screening can
PX0460/A3	As PX0843/A3 with exposed braid for use with PX0465 screening can

Front Panel Mounting Connector



PX0844/A

PX0844/B

- IP68 Sealed through panel
- PX0844/A – USB 2.0 'A' type IP68 connector
- PX0844/B – USB 2.0 'B' type IP68 connector
- PX0844/A3 – USB 3.0 'A' type IP68 connector
- Standard USB interface plug options to rear of panel
- 0.5m standard cable length, other lengths available
- Mates with PX0840 and PX0841 cable connectors

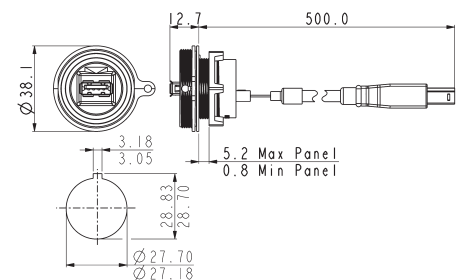

Part no.

Length

Description

PX0844/A/0M50/A	0.5m	IP68 A type USB 2.0, sealed through panel, Sealed 'A' type at front of panel, standard 'A' type at rear
PX0844/A/0M50/B	0.5m	IP68 A type USB 2.0, sealed through panel, Sealed 'A' type at front of panel, standard 'B' type at rear
PX0844/B/0M50/A	0.5m	IP68 B type USB 2.0, sealed through panel, Sealed 'B' type at front of panel, standard 'A' type at rear
PX0844/B/0M50/B	0.5m	IP68 B type USB 2.0, sealed through panel, Sealed 'B' type at front of panel, standard 'B' type at rear
PX0844/A3/0M50/A3	0.5m	IP68 B type USB 3.0, sealed through panel, Sealed 'A' type at front of panel, standard 'A' type at rear

Rear Panel Mounting Connector



PX0848/B

PX0848/A

- PX0848/A – USB 2.0 'A' type IP68 to USB 2.0 'B' type connector
- PX0848/B – USB 2.0 'B' type IP68 to USB 2.0 'A' type connector
- PX0848/A3 – USB 3.0 'A' type IP68 to USB 3.0 'A' type connector
- Mates with PX0840 and PX0841 cable connectors

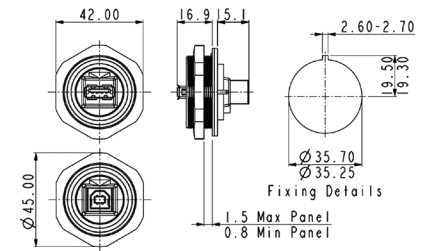

Part no. **Description**

PX0848/A	IP68 A type USB 2.0, rear panel mounted. Sealed A type at front of panel, standard B type at rear
PX0848/B	IP68 B type USB 2.0, rear panel mounted. Sealed B type at front of panel, standard A type at rear
PX0848/AA	IP68 A type USB 2.0, rear panel mounted. Sealed A type at front of panel, standard A type at rear
PX0848/A3	IP68 A type USB 3.0, rear panel mounted. Sealed A type at front of panel, standard A type at rear

Rear Panel Mounting Connector



PX0849/B

PX0849/A

- PX0849/A - USB 2.0 'A' type IP68 connector with 5-way crimp connector
- PX0849/B - USB 2.0 'B' type IP68 connector with 5-way crimp connector
- PX0849/A3 - USB 3.0 'B' type IP68 connector with 10-way crimp connector
- Mates with PX0840 and PX0841 cable connectors

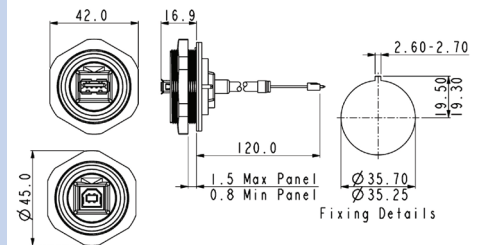

Part no. **Description**

PX0849/A	IP68 A type USB 2.0, rear panel mounted. Sealed A type at front of panel, 5-way header at rear
PX0849/B	IP68 B type USB 2.0, rear panel mounted. Sealed B type at front of panel, 5-way header at rear
PX0849/A3	IP68 A type USB 3.0, rear panel mounted. Sealed A type at front of panel, 10-way header at rear

PCB Panel Mounting Connector- PCB Direct Mount



PX0845/B

PX0845/A

- PX0845/A – USB 2.0 'A' type IP68 connector
- PX0845/B – USB 2.0 'B' type IP68 connector
- PX0845/A3 – USB 3.0 'A' type IP68 connector
- PCB contacts at rear
- Direct PCB mount
- Mates with PX0840 and PX0841 cable connectors

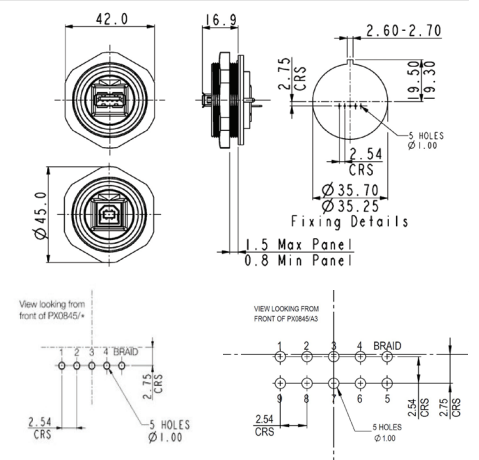

Part no. **Description**

PX0845/A	IP68 A type USB 2.0, rear panel mounted. Sealed A type at front of panel, direct mount PCB contacts at rear
PX0845/B	IP68 A type USB 2.0, rear panel mounted. Sealed A type at front of panel, direct mount PCB contacts at rear
PX0845/A3	IP68 A type USB 3.0, rear panel mounted. Sealed A type at front of panel, direct mount PCB contacts at rear

PCB Adaptor Leads

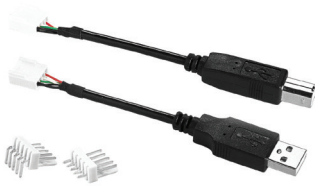

- Standard A and B type USB 2.0 connectors to 5-way crimp adaptor leads
- 5 way-headers, 2.54mm pitch, horizontal or vertical mounting
- Standard A type USB 3.0 to 10-way crimp adaptor leads

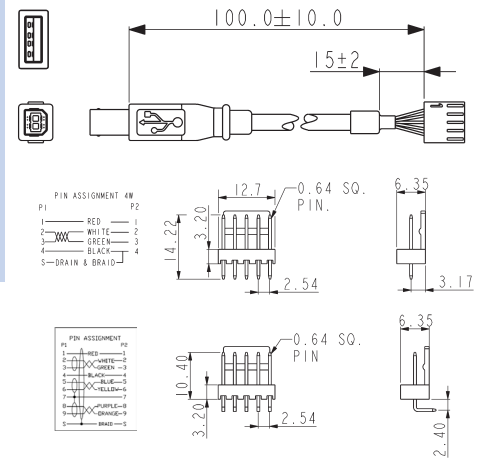

Part no.	Description
14193	USB 2.0 'A' type to 5-way crimp connector
14194	USB 2.0 'B' type to 5-way crimp connector
100286	USB 3.0 'A' type to 10-way crimp connector
14191	5-way PCB header straight
14192	5-way PCB header right angle
100287	10-way PCB header straight
100288	10-way PCB header right angle

Accessories



- Sealing caps to maintain IP68 rating when connectors are not in use
- PX0835 for cable connectors PX0840 & PX0841
- PX0733 for front panel mount connectors PX0842, PX0843 & PX0844
- PX0711 for rear panel mount connectors PX0848, PX0849 & PX0845

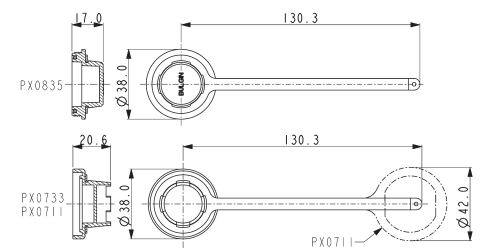

Part no.	Description
PX0835	Sealing Cap for cable connectors (PX0840, PX0841)
PX0733	Sealing Cap for front panel mounting connector (PX0842, PX0843 & PX0844)
PX0711	Sealing Cap for rear panel mounting connector (PX0848, PX0849, PX0845)

USB Flash Drive Cover



PX0852

- For use with USB Flash Drives
- Maintains IP68 rating when mated with panel connector
- For use with 'A' type connectors: PX0842, PX0843, PX0845, PX0848 & PX0849
- Internal accommodation 17.5 x 14.0 x 83mm approx.

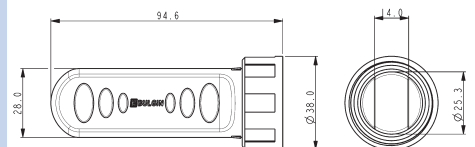

Screening Can



PX0465

- Maintains cable screening directly to panel
- Screening can clips around the panel fixing nut
- For use on PX0460/A, PX0460/B and PX0360/A3

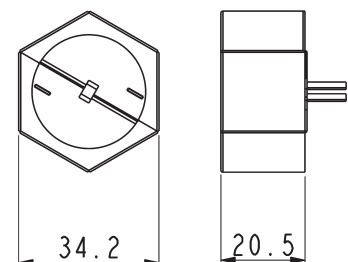

Cables & connectors

Mechanical	IP68, EN60529:1992+A2:2013 (10m depth for 2 weeks)
Sealing	IP69K, Tested in accordance with DIN 40050/Part 9 IP6k9k
Operating temperature	0°C to +70°C
Salt Mist	EN60068-2-52 Test Kb Salt Mist (Cyclic) Marine Severity Level 1

Electrical	
No. of Contacts	4
Current rating	1A
Voltage rating	30V AC (RMS)
Contact resistance	30m Ω max.
Performance	USB version 2.0

Materials - Overmoulded

Overmould material	PVC (black)
Flammability rating	UL94V-0

Materials - Re-wireable and Panel Connectors

Shell material	Steel
Shell plating	Nickel
Contact material	Copper Alloy
Contact plating	30 micro inch Gold
Connector body & locking ring	Glass Loaded Polyester
Panel connector	Acetal
Flammability rating	UL94 HB
'O' rings	Silicone
Panel Gasket - round	Silicone
Panel Gasket - square	Neoprene
Mating cycles	1,000
RoHS	Compliant

Materials - cable

Cable Jacket	PVC (black)
Screen	Tinned copper braid
Flammability	UL94V-0
RoHS	Compliant

Length:		Conductors	Conductors
	2m	Dia	Signal
	3m		Power
	5m		
	4.8mm	2 x 28AWG	2 x 24AWG
	5.0mm	2 x 28AWG	2 x 22AWG
	5.2mm	2 x 25AWG	2 x 20AWG

PCB adaptor leads

Electrical	
No. of conductors	4
Current rating	1A
Voltage rating	30V AC (RMS)
Contact resistance	<10m Ω max.
PCB pitch	2.54mm
Materials	
Moulding	Polycarbonate
Flammability	UL94V-0
Contact material	Copper Alloy
Contact plating	30 micro inch Gold
Wire insulation	PVC (black)
Conductors	4 x 28AWG
Operating temperature	0°C to +70°C
Mating cycles	1,000
RoHS	Compliant

USB 2.0 Cable construction - PX0840, PX0841

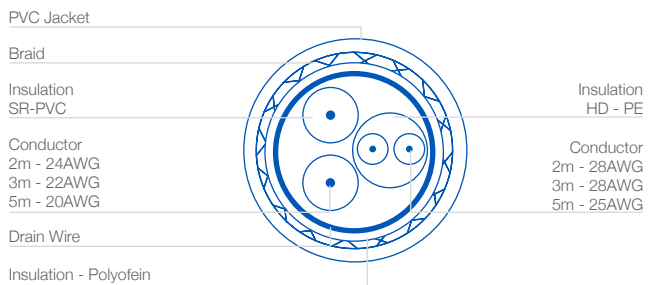

USB 2.0 Contact Diagram - PX0843 & PX0849

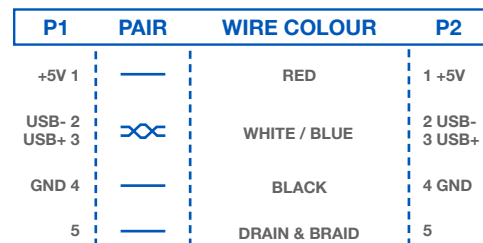

Cables & connectors

Mechanical

Sealing	IP68, EN60529:1992+A2:2013 (10m depth for 2 weeks)
	IP69K, Tested in accordance with DIN 40050/Part 9 IP6k9k
Operating temperature	0°C to +70°C
Salt Mist	EN60068-2-52 Test Kb Salt Mist (Cyclic) Marine Severity Level 1

Electrical

No. of Contacts	9
Current rating	1A
Voltage rating	30V AC (RMS)
Contact resistance	30m Ω max.
Performance	USB version 3.0

Materials - Overmoulded

Overmould material	PVC (black)
Flammability rating	UL94V-0

Materials - Re-wireable and Panel Connectors

Shell material	Steel
Shell plating	Nickel
Contact material	Copper Alloy
Contact plating	Gold
Connector body & locking ring	Glass Loaded Polyester
Panel connector	Acetal
Flammability rating	UL94 HB
'O' rings	Silicone
Panel Gasket - round	Silicone
Panel Gasket - square	Neoprene
Mating cycles	1,000
RoHS	Compliant

Materials - cable

Cable Jacket	PVC (black)
Screen	Tinned copper braid
Flammability	UL94V-0
RoHS	Compliant

Length:		Conductors	Conductors	
		Dia	Signal	
	1m	5.5mm	7 x 28AWG	2 x 24AWG
	2m	5.5mm	7 x 28AWG	2 x 24AWG
3m	5.5mm	7 x 28AWG	2 x 24AWG	

PCB adaptor leads

Electrical

No. of conductors	9
Current rating	1A
Voltage rating	30V AC (RMS)
Contact resistance	30m Ω max.
PCB pitch	2.54mm

Materials

Moulding	Polycarbonate
Flammability	UL94V-0
Contact material	Copper Alloy
Contact plating	Gold
Wire insulation	PVC (black)
Flammability	UL94-V0
Conductors	9 x 28AWG
Operating temperature	0°C to +70°C
Mating cycles	1,000
RoHS	Compliant

USB 3.0 Cable construction - PX0840/A3, PX0841/A3

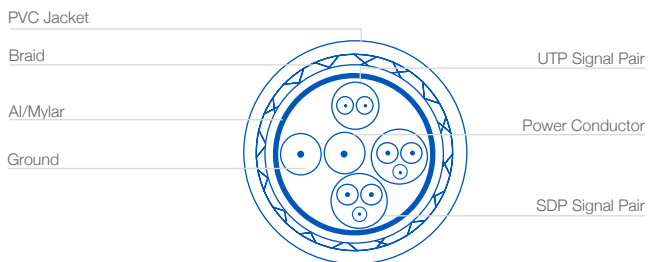

USB 3.0 Contact Diagram - PX0843/A3 & PX0849/A3

P1	PAIR	WIRE COLOUR	P2
+5V 1	—	RED	1 +5V
USB- 2	⊗	WHITE / GREEN	2 USB-
USB+ 3	⊙		3 USB+
GND 4	—	BLACK	4 GND
SSTX- 5	⊗	BLUE / YELLOW	5 SSTX-
SSTX+6	⊙		6 SSTX+
GND 7	—	N/A	7 GND
SSRX-8	⊗	PURPLE / ORANGE	8 SSRX-
SSRX+9	⊙		9 SSRX+
S	—	BRAID	S

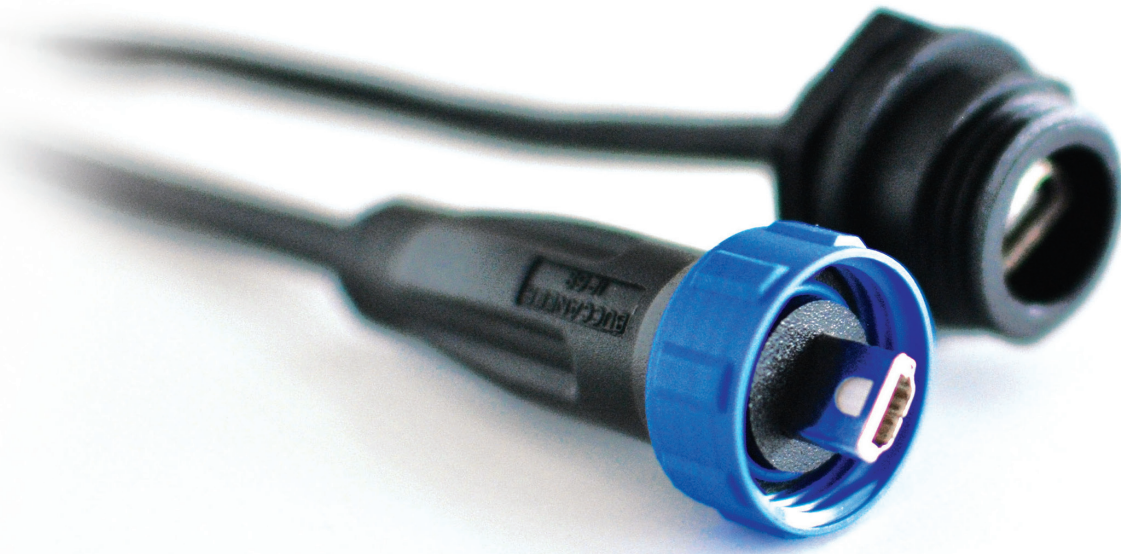

- ⊕ IP68, Tested in accordance with EN60529:1992+A2:2013
- ⊕ IP69K, Tested in accordance with DIN 40050/Part 9 IP6k9k
- ⊕ USB version 2.0 performance
- ⊕ Plug and play capability
- ⊕ Shielded system
- ⊕ Overmoulded cables
- ⊕ Screw coupling
- ⊕ PCB versions
- ⊕ Dust and waterproof to EN60529
- ⊕ Data rates up to 480Mbps
- ⊕ Hot pluggable, standard 4 Contacts interface
- ⊕ High noise immunity
- ⊕ Tamperproof construction
- ⊕ Secure, proven locking system
- ⊕ Direct mounting or via adaptor leads
- ⊕ EN60068-2-52 Test Kb Salt Mist (Cyclic) Marine Severity Level 1

Sealed Mini 'B' to Standard 'A'



PX0441

- IP68 Sealed Mini 'B' Plug to Standard 'A' Plug
- Fully overmoulded construction
- Available in 2, 3 & 4.5m lengths
- Mates with PX0443, PX0446, PX0447, PX0456, PX0457 & PX0458

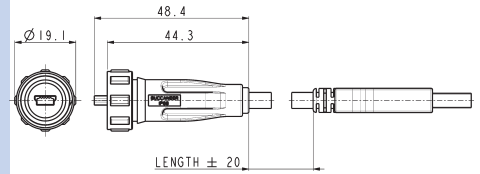

Sealed Mini 'B' to Mini 'A'



PX0442

- IP68 Sealed Mini 'B' Plug to Mini 'A' Plug
- Fully overmoulded construction
- Available in 2, 3 & 4.5m lengths
- Mates with PX0443, PX0446, PX0447, PX0456, PX0457 & PX0458

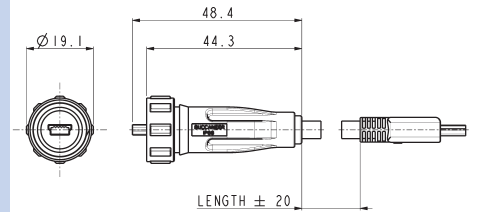

Sealed Mini 'A' to Mini 'B'



PX0444

- IP68 Sealed Mini 'A' Plug to Mini 'B' Plug
- Fully overmoulded construction
- Available in 2, 3 & 4.5m lengths
- Mates with PX0456, PX0457 & PX0458

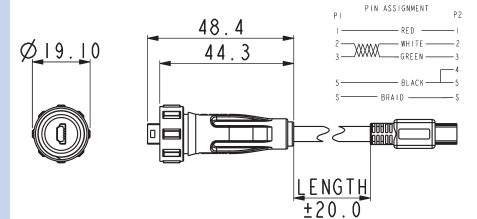

Part No.	Length	Description
PX0441/2M00	2.0m	IP68 Sealed Mini 'B' to Standard 'A' Type USB
PX0441/3M00	3.0m	IP68 Sealed Mini 'B' to Standard 'A' Type USB
PX0441/4M50	4.5m	IP68 Sealed Mini 'B' to Standard 'A' Type USB
PX0442/2M00	2.0m	IP68 Sealed Mini 'B' to Mini 'A' Type USB
PX0442/3M00	3.0m	IP68 Sealed Mini 'B' to Mini 'A' Type USB
PX0442/4M50	4.5m	IP68 Sealed Mini 'B' to Mini 'A' Type USB
PX0444/2M00	2.0m	IP68 Sealed Mini 'A' to Mini 'B' Type USB
PX0444/3M00	3.0m	IP68 Sealed Mini 'A' to Mini 'B' Type USB
PX0444/4M50	4.5m	IP68 Sealed Mini 'A' to Mini 'B' Type USB

Front Panel Mounting Connector



PX0443

- Mini 'B' Type Receptacle
- Leaded with 5 way crimp, for use with PCB header
- Mates with PX0441 & PX0442 type cables

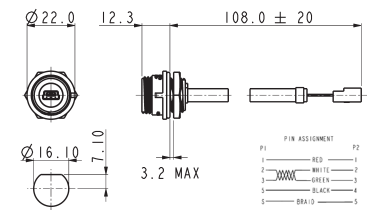

Part no. **Description**

PX0443 IP68 B type Mini USB, front panel mounted. 5 way crimp connector at rear.
PX0459 As PX0443 with exposed braid for use with PX0464 screening can

Front Panel Mounting Connector



PX0456

- Mini 'AB' Type Receptacle
- Leaded with 6 way crimp, for use with PCB header
- Mates with PX0441, PX0442 & PX0444 type cables

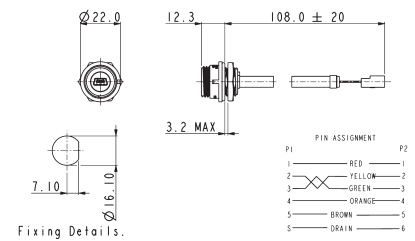

Part no. **Description**

PX0456 IP68 AB type Mini USB, front panel mounted. 6 way crimp connector at rear.

Rear Panel Mounting Connector



PX0446

- Mini 'B' Type Receptacle
- Leaded with 5 way header
- Mates with PX0441 & PX0442 type cables

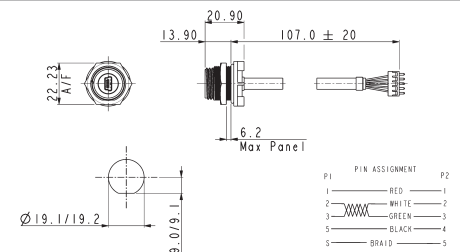

Rear Panel Mounting Connector



PX0447

- Mini 'B' Type Receptacle
- With Plugs for direct PCB mounting
- Mates with PX0441 & PX0442 type cables

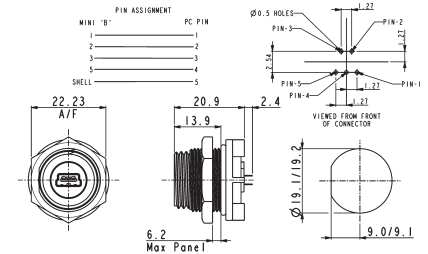

Part no. **Description**

PX0446 IP68 B type Mini USB, rear panel mounted. 5 way header connector at rear.
PX0447 IP68 B type Mini USB, rear panel mounted. PCB terminals at rear.

Rear Panel Mounting Connector



PX0457

- Mini 'AB' Type Receptacle
- Leaded with 6 way header
- Mates with PX0441, PX0442 & PX0444 type cables

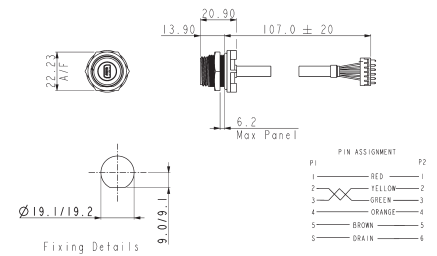

Rear Panel Mounting Connector



PX0458

- Mini 'AB' Type Receptacle
- With Plugs for direct PCB mounting
- Mates with PX0441, PX0442 & PX0444 type cables

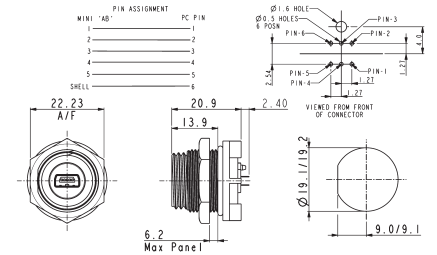

Part no. **Description**

PX0457	IP68 AB type Mini USB, rear panel mounted. 6 way header connector at rear.
PX0458	IP68 AB type Mini USB, rear panel mounted. PCB terminals at rear.

Screening Can



PX0464

- Maintains cable screening directly to panel
- Shielding can clips around the panel fixing nut
- For use on PX0459

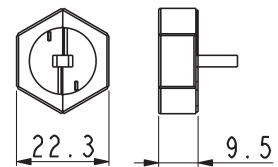

Accessories



- Sealing caps to maintain IP rating when connectors are not in use
- PCB headers for use with PX0443 & PX0456

Part no. **Description**

PX0485	Sealing cap for use with PX0441, PX0442 & PX0444
PX0480	Sealing cap for use with PX0443 & PX0456
PX0484	Sealing cap for use with PX0446, PX0447, PX0457 & PX0458
14191	5 way straight header
14192	5 way right angle header
14563	6 way straight header
14564	6 way right angle header

Cables & connectors

Mechanical

Sealing	IP68, EN60529:1992+A2:2013 (10m depth for 2 weeks) IP69K, Tested in accordance with DIN 40050/Part 9 IP6k9k
Operating temperature	-35C to +70C
Salt Mist	EN60068-2-52 Test Kb Salt Mist (Cyclic) Marine Severity Level 1

Electrical

No. of Contacts	4 and 5
Current rating	1A
Voltage rating	30V AC, 42V DC
Contact resistance	50m Ω max.
Performance	USB version 2.0

Materials - Overmoulded

Overmould material	PVC (black)
Flammability rating	UL94V-0

Materials - Re-wireable and Panel Connectors

Shell material	Steel
Shell plating	Nickel
Contact material	Copper Alloy
Contact plating	50 micro inch Gold
Connector body & locking ring	Polyester
Panel connector	Nylon 6
Flammability rating	UL94V-0
'O' rings	Nitrile
Mating cycles	5,000
RoHS	Compliant

Materials - cable

Cable Jacket	PVC (black)
Screen	Tinned copper braid
Flammability	UL94V-0
RoHS	Compliant

Length:	Dia	Conductors Signal	Conductors Power
2m	4.8mm	2 x 28AWG	2 x 24AWG
3m	5.0mm	2 x 28AWG	2 x 22AWG
5m	5.2mm	2 x 25AWG	2 x 20AWG

Cable construction - PX0441, PX0442, PX0444

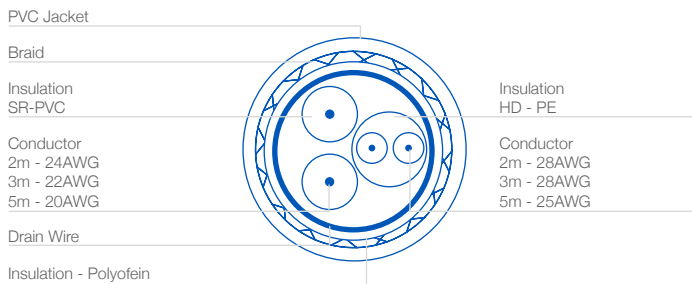



- ⊕ IP68, Tested in accordance with EN60529:1992+A2:2013
- ⊕ IP69K, Tested in accordance with DIN 40050/Part 9 IP6k9k
- ⊕ 50Ω Impedance SMB connector
- ⊕ Frequency range 0-4GHz
- ⊕ Contact resistance
 - centre - 6mΩ max.
 - outer - 2.5mΩ max.
- ⊕ Gold plated contacts
- ⊕ Diameter over coupling ring 19mm
- ⊕ Body moulding, Nylon UL94-V0 rated
- ⊕ Two versions of Flex Connector
 - re-wireable
 - pre-wired - lengths 1m, 3m & 5m
- ⊕ Panel connector
 - pre-wired - lengths 0.5m, 1m & 1.5m
- ⊕ Cable accommodation (flex re-wireable), RG-174
- ⊕ Cable type (pre-wired connectors), RG-174

Re- Wireable Flex Connector



PX0415/1

- Mates with Panel connector (PX0414)
- Re-wireable connector
- For RG-174 cable
- Supplied with SMB plug

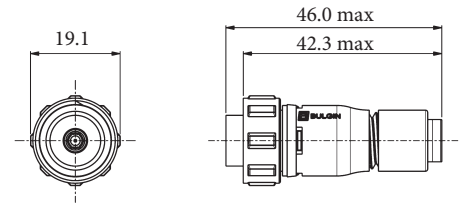

Part no.	Description
PX0415/1	Re-wireable connector with SMB Plug - for RG-174 cable

Pre- Wireable Flex Connector



PX0416/xMxx

- Mates with Panel connector (PX0414)
- Pre-wired
- Overmoulded construction
- Supplied with SMB plug terminated with RG-174 cable
- 1m, 3m & 5m cable lengths

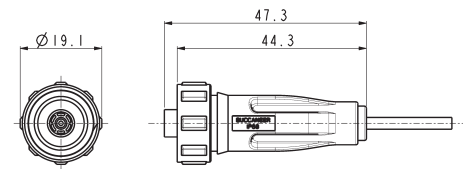

Part no.	Description
PX0416/1M00	Overmoulded connector with SMB plug - cable length 1m
PX0416/3M00	Overmoulded connector with SMB plug - cable length 3m
PX0416/5M00	Overmoulded connector with SMB plug - cable length 5m

Front Panel Mount Connector



PX0414/xMxx

- Mates with Flex connectors (PX0415, PX0416)
- Single hole fixing
- Supplied with SMB jack terminated with RG-174 cable
- U.FL cable version also available

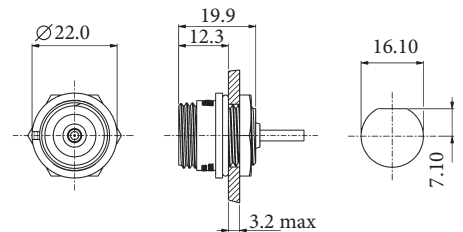

Part no.	Description
PX0414/0M50	Panel connector with SMB jack - cable length 0.5m
PX0414/1M00	Panel connector with SMB jack - cable length 1m
PX0414/1M50	Panel connector with SMB jack - cable length 1.5m

Sealing Caps



PX0480 PX0481 PX0485

- Sealing caps maintain IP rating when connectors are not in use

Part no.	Description
PX0480	Sealing cap for PX0414 chassis connector
PX0481	Sealing cap for PX0415 re-wireable flex connectors
PX0485	Sealing cap for PX0416 overmoulded flex connector
14319	Hand crimp tool for SMB



Electrical

Impedance:	50Ω
Frequency Range:	0-4GHz
Contact Resistance:	
Centre:	6mΩ (max.)
Outer:	2.5mΩ (max.)
Insulator Resistance:	1000MΩ (max.)

Mechanical:

Sealing:	IP68, EN60529:1992+A2:2013 (10m depth for 2 weeks)
	IP69K, Tested in accordance with DIN 40050/Part 9 IP6k9k
Salt Mist	EN60068-2-52 Test Kb Salt Mist (Cyclic) Marine Severity Level 1
Cable Acceptance:	RG-174
Insertion/Withdrawal Force:	
Insertion Force:	36N
Withdrawal Force:	36N
Cable Retention Force:	18N
Mating Cycles:	500
Operating Temperature:	-20°C to +80°C

Material:

PX0415/1 and PX0414	
Body Mouldings:	Polyamide
Flammability Rating:	UL94V-0
UV Resistance:	To EN 50021:1999
PX0416	
Body Mouldings:	PVC (black)
Flammability Rating:	UL94V-0
O Rings:	Nitrile
Panel Sealing O Ring:	Nitrile
SMB Connector	
Body:	Brass to QQ-B-626, Gold Plated
Centre Contact:	
Plug:	Brass to QQ-B-626, Gold Plated
Jack:	Beryllium Copper to QQ-B-530, Gold Plated
Insulator:	Teflon
Crimp Ferrules:	Annealed Copper
RoHS	Compliant

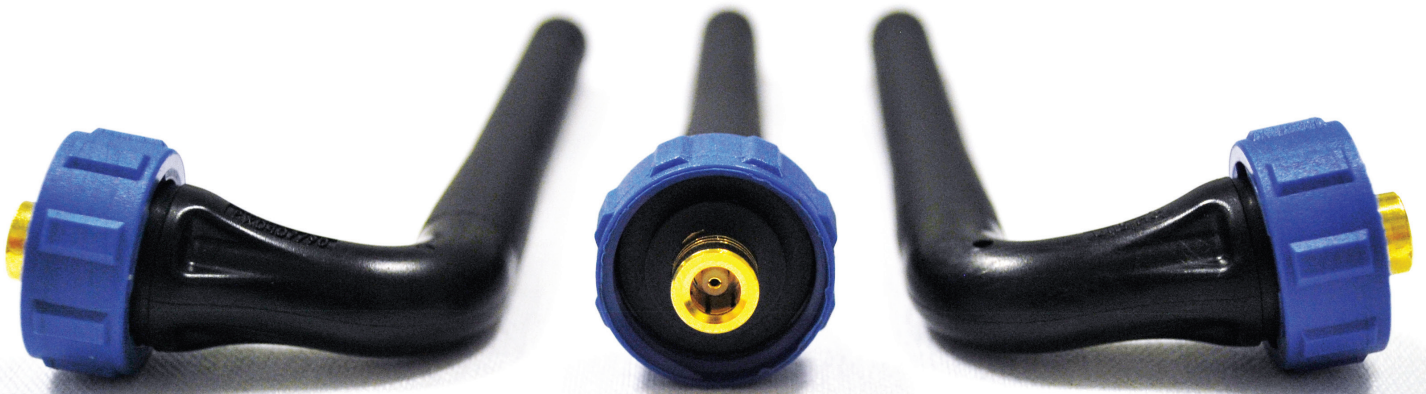

SMB Antenna

- ⊕ IP68, Tested in accordance with EN60529:1992+A2:2013
- ⊕ IP69K, Tested in accordance with DIN 40050/Part 9 IP6k9k
- ⊕ SMB 50 ohm interface
- ⊕ For use with SMB Buccaneer
- ⊕ Three frequency bands:
440 to 470MHz
850-900/1800/1900MHz
2.4 to 2.5GHz
- ⊕ Maintains sealing integrity of equipment

Bluetooth Cable Replacement

- ⊕ IP68, Tested in accordance with EN60529:1992+A2:2013
- ⊕ RS485/RS232 serial interfaces
- ⊕ Serial data to Bluetooth
- ⊕ Wireless transparent data connection
- ⊕ Up to 100m range (class 1)
- ⊕ Maintains sealing integrity of equipment

SMB Antenna



PX0407



PX0407/90

- Dust & waterproof to IP68
EN60529 when mated
- Secure screw thread locking
- Built-in sealed antenna
- Mates with SMB Buccaneer
PX0414
- Frequency bands:
2.4 to 2.5GHz
440 to 470MHz
850-900/1800/1900MHz

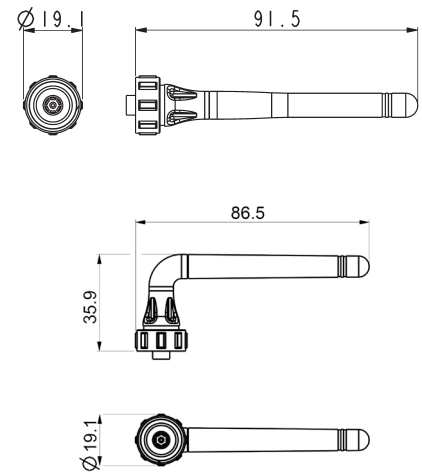

Part no.	Description
PX0407	IP68 rated, Buccaneer Antenna, 2.4 to 2.5GHz frequency band
PX0408	IP68 rated, Buccaneer Antenna, 440 to 470MHz frequency band
PX0409	IP68 rated, Buccaneer Antenna, 850-900/1800/1900MHz frequency band
PX0407/90	IP68 rated, Buccaneer Antenna, 2.4 to 2.5GHz frequency band
PX0408/90	IP68 rated, Buccaneer Antenna, 440 to 470MHz frequency band
PX0409/90	IP68 rated, Buccaneer Antenna, 850-900/1800/1900MHz frequency band

Specification

Electrical

Frequency	
PX0407	2.4 to 2.5GHz
PX0408	440 to 470MHz
PX0409	850-900/1800/1900MHz

Configuration	
PX0407	¼ Wavelength
PX0408	½ Wavelength
PX0409	½ Wavelength

Radiation	Omnidirectional
Polarization	Vertical
Impedance	50Ω nominal
VSWR	<2

Mechanical

Sealing	IP68, EN60529:1992+A2:2013, when mated (10m depth for 2 weeks) IP69K, Tested in accordance with DIN 40050/Part 9 IP6k9k
Operating Temperature:	-20°C to +65°C
Salt Mist	EN60068-2-52 Test Kb Salt Mist (Cyclic) Marine Severity Level 1

Material

Body Mouldings	PVC
Flammability Rating	UL94V-0
UV Resistance	EN50021:1999
RoHS	Compliant

PX0407 Polar plots - 2.4 to 2.5GHz Frequency Band

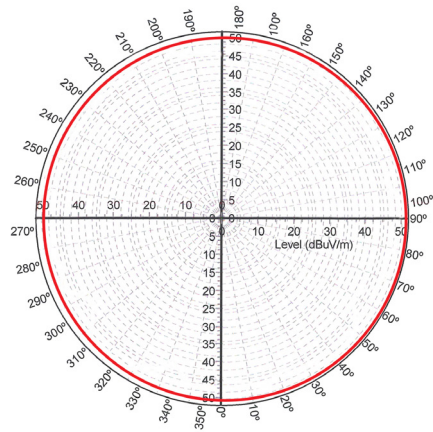
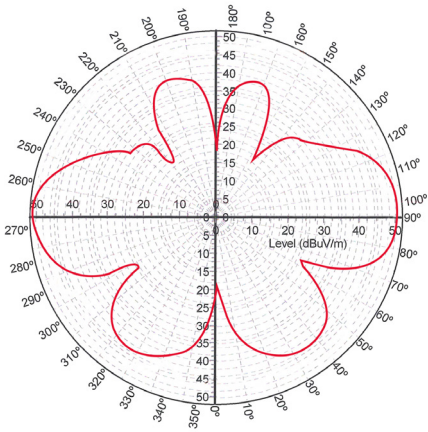

PX0407 Radiation Pattern plots

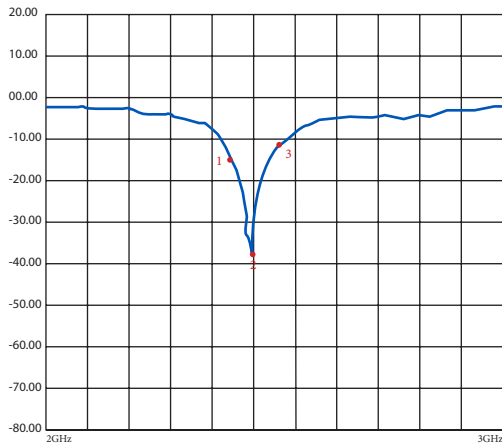

- 1 -12.624 dB 2.4000 GHz
- 2 -34.951 dB 2.45000 GHz
- 3 -12.777 dB 2500.000 000 MHz

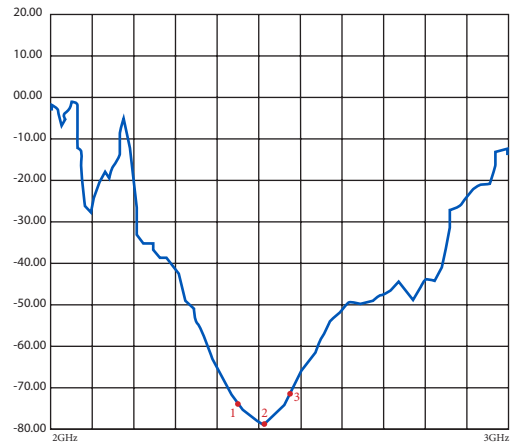

- 1 1.5659 dB 2.40000 GHz
- 2 1.6514 dB 2.45000 GHz
- 3 1.6032 dB 2500.000 000 MHz

400 Series - Wireless Buccaneer

Polar/Antenna Plots



PX0408 Polar plots - 440 to 470MHz Frequency Band

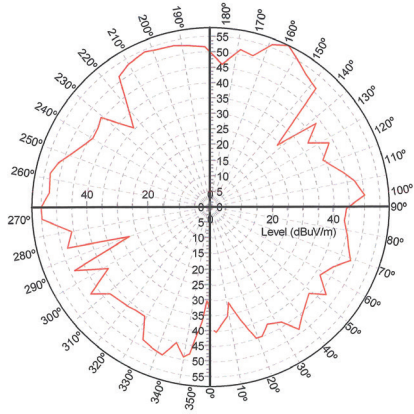

Pattern Field

E

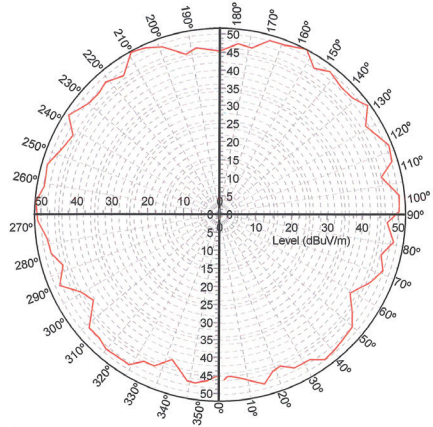

Pattern Field

H

PX0408 Radiation Pattern plots

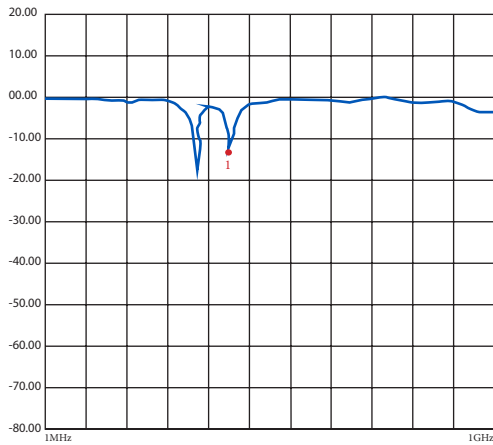

1 450.00000 MHz -13.300 dB

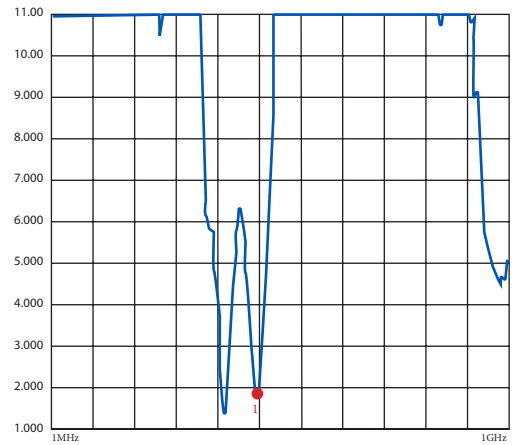

1 450.00000 MHz -13.300 dB

400 Series - Wireless Buccaneer

Polar/Antenna Plots



PX0409 / 850-900MHz Polar plots

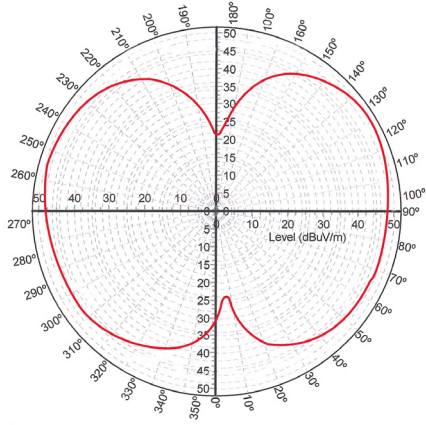

Pattern Field E

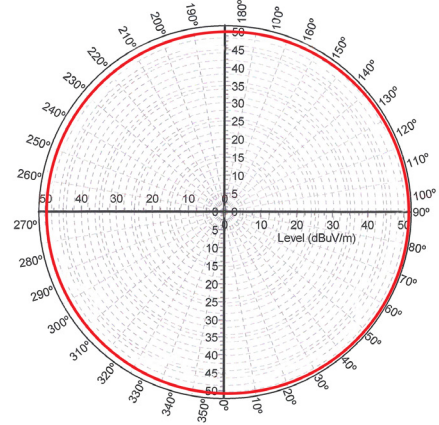

Pattern Field H

PX0409 / 850-900MHz Radiation Pattern plots

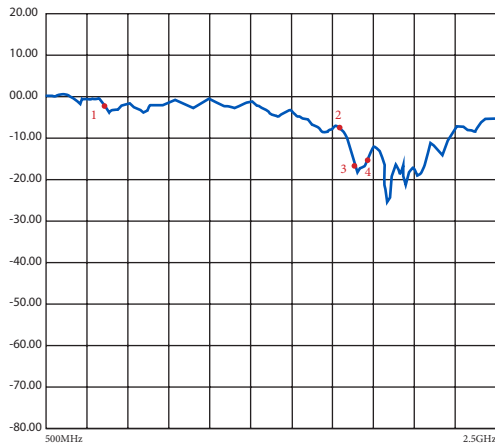

- 1 900.00000 MHz -3.4307 dB
- 2 1.8000000 GHz -9.0130 dB
- 3 1.8800000 GHz -19.516 dB
- 4 1.9000000 GHz -20.297 dB

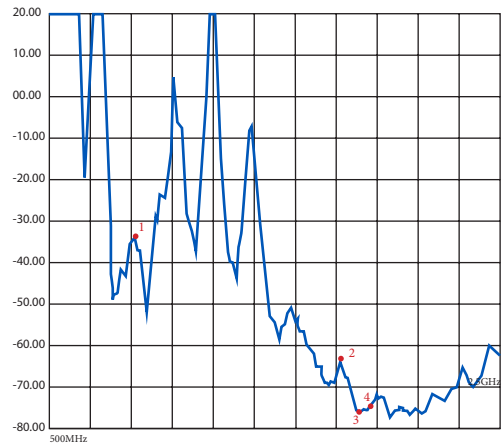

- 1 900.00000 MHz 5.1694 dB
- 2 1.8000000 GHz 2.2481 dB
- 3 1.8800000 GHz 1.2377 dB
- 4 1.9000000 GHz 1.2052 dB

PX0409 / 1800MHz Polar plots

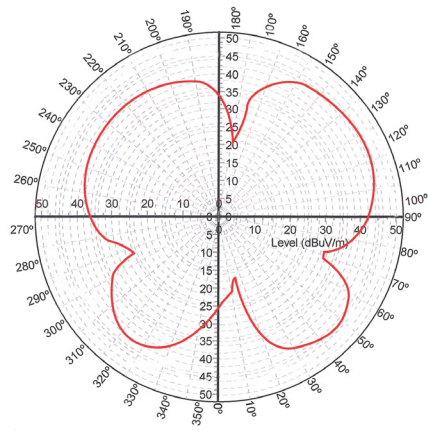

Pattern Field

E

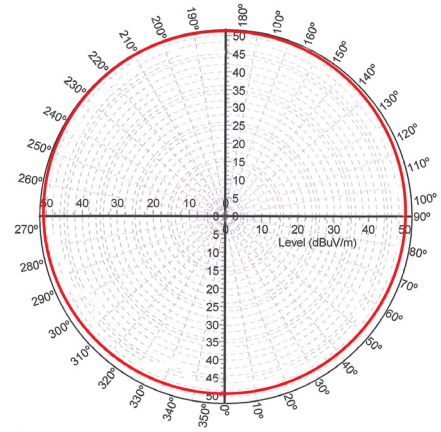

Pattern Field

H

PX0409 / 1800MHz Radiation Pattern plots

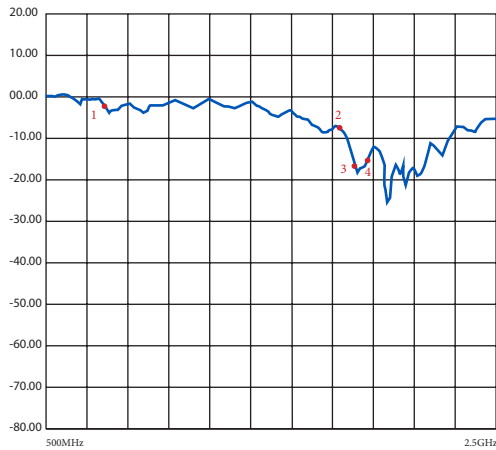

- 1 900.00000 MHz -3.4307 dB
- 2 1.8000000 GHz -9.0130 dB
- 3 1.8800000 GHz -19.516 dB
- 4 1.9000000 GHz -20.297 dB

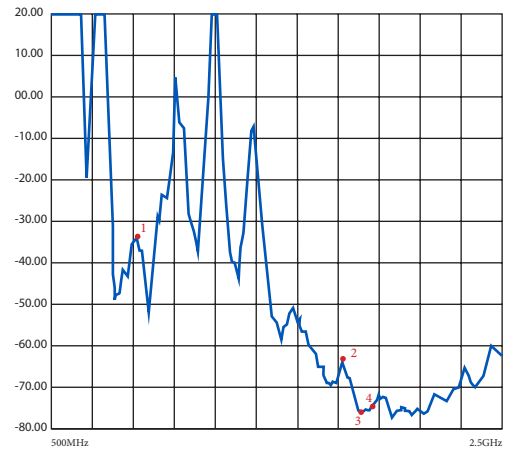

- 1 900.00000 MHz 5.1694 dB
- 2 1.8000000 GHz 2.2481 dB
- 3 1.8800000 GHz 1.2377 dB
- 4 1.9000000 GHz 1.2052 dB

400 Series - Wireless Buccaneer

Polar/Antenna Plots



PX0409 / 1900MHz Polar plots

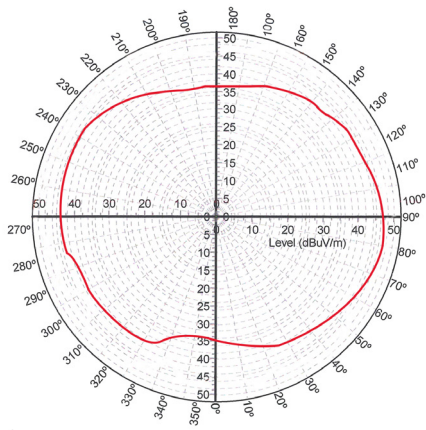

Pattern Field

E

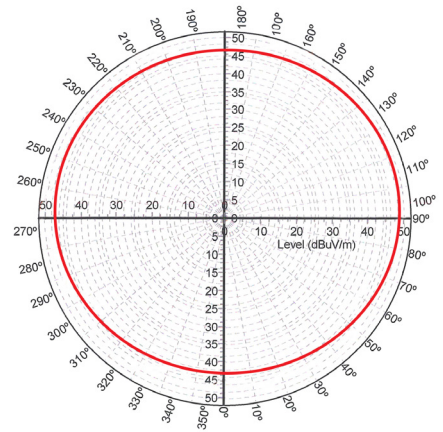

Pattern Field

H

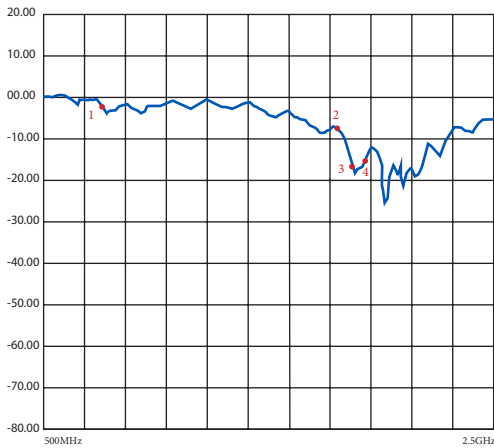

- 1 900.00000 MHz -3.4307 dB
- 2 1.8000000 GHz -9.0130 dB
- 3 1.8800000 GHz -19.516 dB
- 4 1.9000000 GHz -20.297 dB

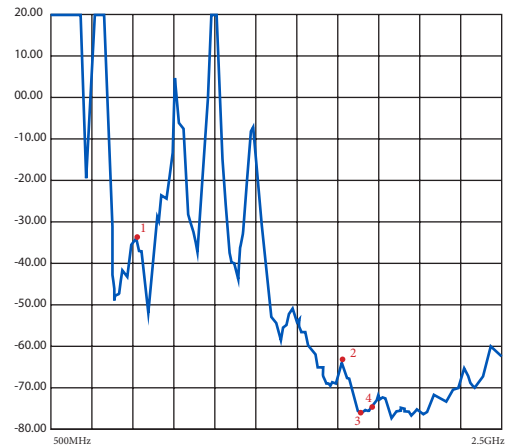

- 1 900.00000 MHz 5.1694 dB
- 2 1.8000000 GHz 2.2481 dB
- 3 1.8800000 GHz 1.2377 dB
- 4 1.9000000 GHz 1.2052 dB

Our 600 Series - [Ethernet Buccaneer Connectors](#) provide a reliable ethernet connection in environments where regular Ethernet connectors would be prone to damage or malfunction. They are designed to [withstand the harshest of environments](#), such as [outdoor, industrial, or military applications](#). These connectors are built with materials & features that protect against dust & water ingress, vibrations & extreme temperatures. The 600 series connectors come with [EMI shielded & unshielded versions](#) and are available in jam nut, flange mount, inline plug, and plug options.



Key Features:

- ⊞ Cat 5e & Cat 6a compliant
- ⊞ Supports 10, 100 & 1,000 Mbps data transmissions
- ⊞ POE, POE+ & POE++
- ⊞ DATA, VOIP & IPTV in Harsh Environments
- ⊞ Durability >500 cycles
- ⊞ Operating temperature -40°C to +100°C
- ⊞ Screw coupling
- ⊞ IP68-rated
- ⊞ EMI Shielded & Unshielded versions
- ⊞ Transversely Sealed IP68 when mated & unmated
- ⊞ Sealing Cap option is available

Transversely Sealed Inline Plug



PXM0608

- ⊕ IP68 when mated & unmated
- ⊕ Female RJ45 interface
- ⊕ Screw coupling
- ⊕ Mates with Plug with cap & Plug
- ⊕ Standard RJ45 cable to be sourced or modular connector

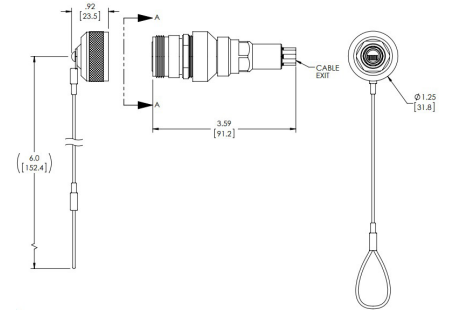

Part No.	Category	Plating	Colour	Cable Entry
PXM0608NSANBK4868	Standard RJ45 cable to be sourced	Anodised	Black	4.82-6.85mm
PXM06086FANBK4868	Category 6a modular connector supplied	Anodised	Black	4.82-6.85mm

Plug with Cap



PXM0600

- ⊕ IP68 when mated
- ⊕ Male RJ45 to be installed
- ⊕ Screw coupling
- ⊕ Mates with Transversely Sealed Inline Plug, Jam Nut & Flange Mount
- ⊕ Standard RJ45 cable to be sourced or modular connector

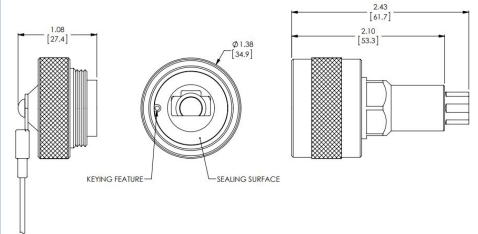

Part No.	Category	Plating	Colour	Cable Entry
PXM0600NSANBK4868	Standard RJ45 cable to be sourced	Anodised	Black	4.82-6.85mm
PXM0600NSANBK6883	Standard RJ45 cable to be sourced	Anodised	Black	6.88-8.38mm
PXM06006MANBK4868	Category 6a modular connector supplied	Anodised	Black	4.82-6.85mm
PXM06006MENBK4868	Category 6a modular connector supplied	Electroless Nickel	Black	4.82-6.85mm
PXM06006MENBK6883	Category 6a modular connector supplied	Electroless Nickel	Black	6.88-8.38mm

Plug



PXM0609

- ⊕ IP68 when mated
- ⊕ Male RJ45 to be installed
- ⊕ Screw coupling
- ⊕ Mates with Transversely Sealed Inline Plug, Jam Nut & Flange Mount
- ⊕ Standard RJ45 cable to be sourced or modular connector

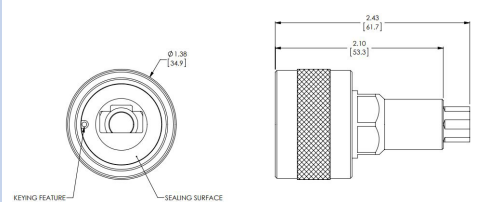

Part No.	Category	Plating	Colour	Cable Entry
PXM0609NSANBK4868	Standard RJ45 cable to be sourced	Anodised	Black	4.82-6.85mm
PXM0609NSANBK6883	Standard RJ45 cable to be sourced	Anodised	Black	6.88-8.38mm

Jam Nut with Cap



- ⊕ IP68 when mated
- ⊕ Female RJ45 interface
- ⊕ Screw coupling
- ⊕ Mates with Plug with cap & Plug
- ⊕ Panel thickness: 1.5-5mm

PXM0610

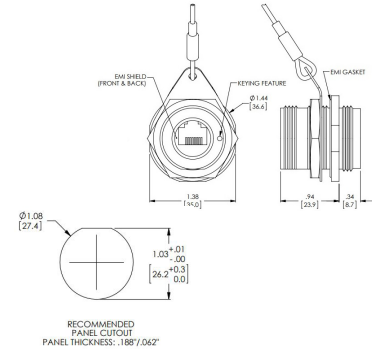

Part No.	Category	Plating	Colour	EMI Protection
PXM06105FANBKUS	Category 5e	Anodised	Black	Unshielded
PXM06106FENBKSH	Category 6a	Electroless Nickel	Black	Shielded

Jam Nut



- ⊕ IP68 when mated
- ⊕ Female RJ45 interface
- ⊕ Screw coupling
- ⊕ Mates with Plug with cap & Plug
- ⊕ Panel thickness: 1.5-5mm

PXM0619

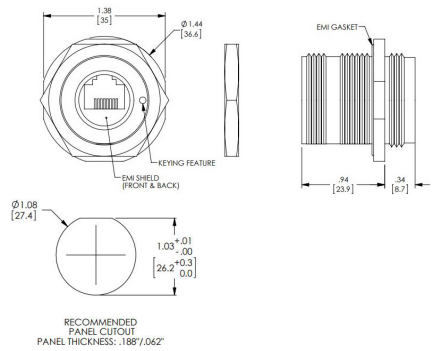

Part No.	Category	Plating	Colour	EMI Protection
PXM06195FANBKUS	Category 5e	Anodised	Black	Unshielded

Transversely Sealed Flange Mount



- ⊕ IP68 when mated & unmated
- ⊕ Female RJ45 interface
- ⊕ Screw coupling
- ⊕ Mates with Plug with cap & Plug

PXM0628

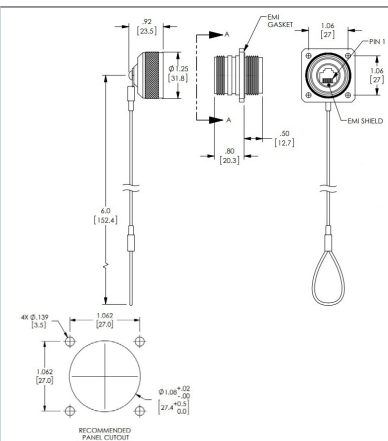

Part No.	Category	Plating	Colour	EMI Protection
PXM06285FANBKUS	Category 5e	Anodised	Black	Unshielded

Flange Mount with Cap & Mounting Hardware



PXM0627

- ⊕ IP68 when mated
- ⊕ Female RJ45 interface
- ⊕ Screw coupling
- ⊕ Mates with Plug with cap & Plug
- ⊕ Panel thickness: 1.5-5mm

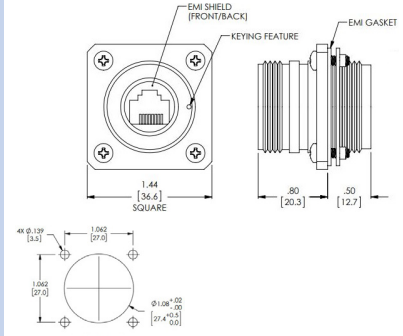

Part No.	Category	Plating	Colour	EMI Protection
PXM06275FANBKUS	Category 5e	Anodised	Black	Unshielded
PXM06276FENBKSH	Category 6a	Electroless Nickel	Black	Shielded
PXM06276FANBKUS	Category 6a	Anodised	Black	Unshielded

Flange Mount with Mounting Hardware



PXM0626

- ⊕ IP68 when mated
- ⊕ Female RJ45 interface
- ⊕ Screw coupling
- ⊕ Mates with Plug with cap & Plug
- ⊕ Panel thickness: 1.5-5mm

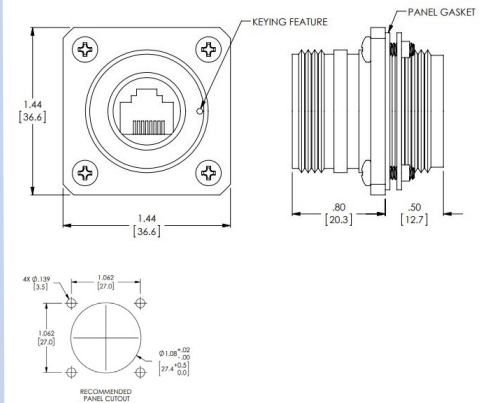

Part No.	Category	Plating	Colour	EMI Protection
PXM06265FANBKUS	Category 5e	Anodised	Black	Unshielded

Flange Mount



PXM0629

- ⊕ IP68 when mated
- ⊕ Female RJ45 interface
- ⊕ Screw coupling
- ⊕ Mates with Plug with cap & Plug

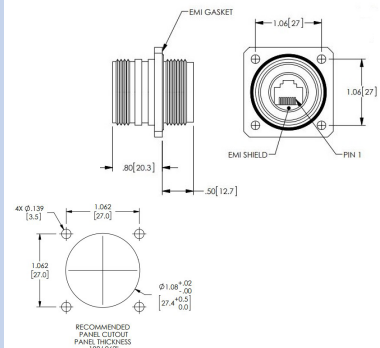

Part No.	Category	Plating	Colour	EMI Protection
PXM06295FANBKUS	Category 5e	Anodised	Black	Unshielded



Product Specification:

Electrical

Shock Resistance:	100g 6ms
Humidity:	98%
Insertion Loss:	1000 BASE-T
Hi-pot high-voltage Test:	600VAC-60Hz, 900uA
Shell-to-shell conductivity:	1A @ 1.5VDC, 100hrs
Electromagnetic Shielding Effectiveness:	20kHz, 150kHz, 14MHz, 400MHz, 600MHz, 1GHz, 2GHz, 8GHz, 10GHz, vert. and horz., <-60dB

Material:

Body:	Aluminium
Plating:	Available in Anodised, Electroless Nickel
Hardware:	Stainless Steel
Seals:	Silicone
Flammability:	Compliant to V0, V1, 10sec each
Lanyard:	Stainless Steel
RoHS	Compliant

Mechanical:

Cycles:	>500
Sealing:	IP68, 1m depth for 48hrs
Dust Test:	20mBAR air pressure, 8hrs
Termination:	Crimp terminals
Salt Spray:	500hr
Mechanical Shock:	100G (6ms)
Operating Temperature Range:	-40° C to +100° C
Panel Mount Thickness:	1.5-5mm
Panel Mount Nut Torque:	1.6-1.7Nm



- ⊞ IP66, IP68 and IP69K rated
- ⊞ USB version 2.0 performance
- ⊞ Plug and play capability
- ⊞ Shielded system
- ⊞ Overmoulded cables
- ⊞ EN60068-2-52 Test Kb Salt Mist (Cyclic) Marine Severity Level 1
- ⊞ Data rates up to 480Mbps
- ⊞ Secure, proven locking system
- ⊞ Tamperproof Construction
- ⊞ Colour coded O-rings & washers for easy identification purposes

Sealed Micro 'B' to Standard 'A'



PXP4040/B

- Sealed Micro 'B' plug to Standard 'A' plug
- Available in 2, 3 & 5m lengths
- Plug variant mates with PXP4043

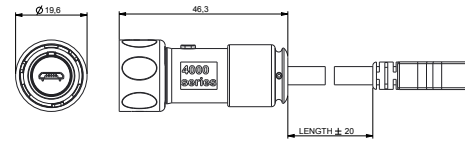

Part No.	Length	Description
PXP4040/B/2M00	2.0m	IP-sealed micro 'B' to Standard 'A' type USB
PXP4040/B/3M00	3.0m	IP-sealed micro 'B' to Standard 'A' type USB
PXP4040/B/5M00	5.0m	IP-sealed micro 'B' to Standard 'A' type USB

Rear Panel Mounting Connector



PXP4043

- Micro 'B' type
- Leaded with 5 way header
- Socket variant mates with PXP4040/B type cables

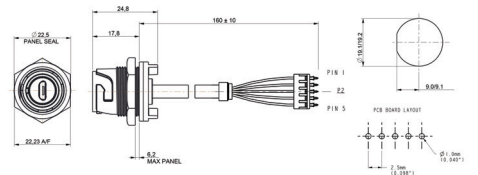

Part no.	Description
PXP4043	IP-sealed B type Micro USB, rear panel mounted. 5 way header connector at rear.

Accessories



- Sealing caps to maintain IP rating when connectors are not in use

Part no.	Description
PXP4081	Sealing cap for use with PXP4010 & PXP4040/B
PXP4082	Sealing cap for use with PXP4011
PXP4083	Sealing cap for use with PXP4013 & PXP4043

Gland Packs



Part no.	Description
PXP4088/0305	Pack of 4 pairs cable glands and collets to suit cables from 3.0 to 5.0mm diameter.
PXP4088/0507	Pack of 4 pairs cable glands and collets to suit cables from 5.0 to 7.0mm diameter.

O-ring & washer pack



Part no.	Description
PXP4089/YL	Yellow coloured O-ring and washer pack
PXP4089/BL	Blue coloured O-ring and washer pack
PXP4089/RD	Red coloured O-ring and washer pack
PXP4089/WH	White coloured O-ring and washer pack
PXP4089/GN	Green coloured O-ring and washer pack

Cables & connectors

Mechanical

Sealing	IP69K, DIN40050-9 IP68, EN60529:1992+A2:2013 (10m depth for 2 weeks) IP66, EN60529:1992+A2:2013
Panel Mount Nut	1.0 - 1.1NM (91lb.in)
Operating temperature	-40°C to +70°C
Salt Mist	EN60068-2-52 Test Kb Salt Mist (Cyclic) Marine Severity Level 1

Electrical

No. of Contacts	4 and 5
Current rating	1A
Voltage rating	30V AC, 42V DC
Contact resistance	50m Ω max.
Performance	USB version 2.0

Materials - Re-wireable and Panel Connectors

Shell material	Steel
Shell plating	Nickel
Contact material	Copper Alloy
Contact plating	50 micro inch Gold
Connector body & locking ring	PC/PBT
Panel connector	PC/PBT
Flammability rating	UL94V-0
'O' rings	Silicone
Mating cycles	1,000
RoHS	Compliant

Materials - cable

Cable Jacket	PVC (black)
Screen	Tinned copper braid
Flammability	UL94V-0
RoHS	Compliant

Length:	Dia	Conductors	Conductors
		Signal	Power
2m	4.8mm	2 x 28AWG	2 x 24AWG
3m	5.0mm	2 x 28AWG	2 x 22AWG
5m	5.2mm	2 x 25AWG	2 x 20AWG

Cable construction - PXP4040/B & PXP4043

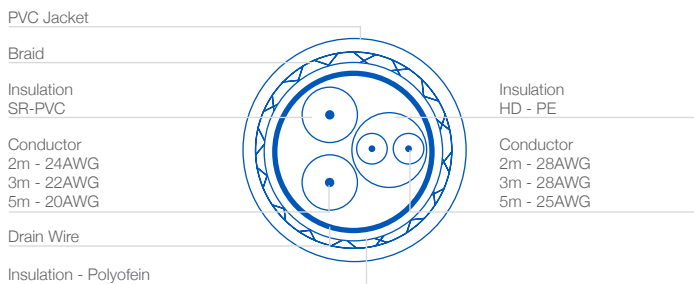



- ⊕ IP66, IP68 and IP69K rated
- ⊕ USB3.2 supported
- ⊕ Plug and play capability
- ⊕ Shielded system
- ⊕ Secure, proven locking system
- ⊕ EN60068-2-52 Test Kb Salt Mist (Cyclic) Marine Severity Level 1
- ⊕ Data rates up to 20 Gbps
- ⊕ Tamperproof Construction
- ⊕ Colour coded O-rings & washers for easy identification purposes



Sealed 'C' type to Standard 'C'

- Sealed Plug USB 'C' to Standard Plug USB 'C'
- Available in 1, 2, 3 & 5m lengths
- Plug variant mates with PXP4043/C
- USB 3.2 Gen 2x2 Supported

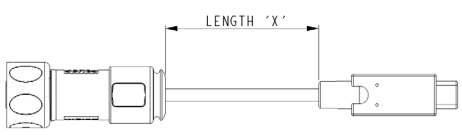

PXP4041/C/C

Part No.	Length	Description
PXP4041/C/C/1M00	1.0m	IP-sealed 'C' type to Standard 'C' type USB
PXP4041/C/C/2M00	2.0m	IP-sealed 'C' type to Standard 'C' type USB
PXP4041/C/C/3M00	3.0m	IP-sealed 'C' type to Standard 'C' type USB
PXP4041/C/C/5M00	5.0m	IP-sealed 'C' type to Standard 'C' type USB



Sealed 'C' type to Standard 'A'

- Sealed Plug USB 'C' to Standard Plug USB 'A'
- Available in 1, 2, 3 & 5m lengths
- Plug variant mates with PXP4043/C
- USB 3.2 Gen 1 Supported

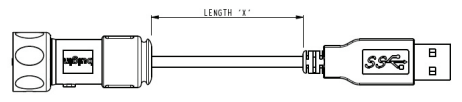

PXP4040/C/A

Part No.	Length	Description
PXP4040/C/A/1M00	1.0m	IP-sealed 'C' type to Standard 'A' type USB
PXP4040/C/A/2M00	2.0m	IP-sealed 'C' type to Standard 'A' type USB
PXP4040/C/A/3M00	3.0m	IP-sealed 'C' type to Standard 'A' type USB
PXP4040/C/A/5M00	5.0m	IP-sealed 'C' type to Standard 'A' type USB

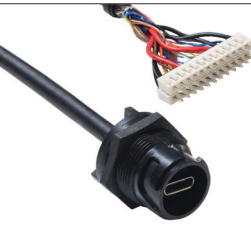

Rear Panel Mount

- Sealed Socket USB 'C' Connector
- Leaded with 2x 12 way header
- Socket variant mates with PXP4040/C/A and PXP4041/C/C type cables
- USB 3.2 Gen 2 Supported

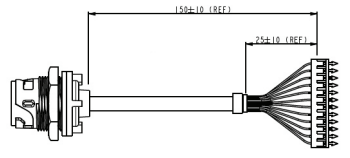

PXP4043/C

Part no.	Description
PXP4043/C	IP-sealed 'C' type USB, rear panel mounted. 2x 12 way header connector at rear



Sealing Caps

- Sealing caps to maintain IP rating when connectors are not in use

Part no.	Description
PXP4081	Sealing cap for use with PXP4040/C/A and PXP4041/C/C
PXP4083	Sealing cap for use with PXP4043/C

O-ring & washer pack



Part no.	Description
PXP4089/YL	Yellow coloured O-ring and washer pack
PXP4089/BL	Blue coloured O-ring and washer pack
PXP4089/RD	Red coloured O-ring and washer pack
PXP4089/WH	White coloured O-ring and washer pack
PXP4089/GN	Green coloured O-ring and washer pack

Cables & connectors

Mechanical

Sealing	IP69K, DIN40050-9 IP68, EN60529:1992+A2:2013 (10m depth for 2 weeks) IP66, EN60529:1992+A2:2013
Panel Mount Nut	1.0 - 1.1Nm (91lb.in)
Operating temperature	-40°C to +80°C
Salt Mist	EN60068-2-52 Test Kb Salt Mist (Cyclic) Marine Severity Level 1

Electrical

No. of Contacts	2x 12 way
Current rating	5A
Voltage rating	≤ 30V AC
Contact resistance	40m Ω max.
USB3.2 Gen 1:	5Gbps (2m maximum length)
USB3.2 Gen 2:	10Gbps (1m maximum length)
USB3.2 Gen 1x2:	10Gbps (2m maximum length)
USB3.2 Gen 2x2:	20Gbps (1m maximum length)

Materials - Re-wireable and Panel Connectors

Shell material	Stainless Steel
Shell plating	Nickel
Contact material	Copper Alloy
Contact plating	30 micro inch Gold
Connector body & locking ring	PC/PBT
Panel connector	PC/PBT
Flammability rating	UL94V-0
'O' rings	Silicone
Mating cycles	1,000
RoHS	Compliant

Materials - cable

Cable Jacket	PVC (black)
Screen	Tinned copper braid
Flammability	UL94V-0
RoHS	Compliant

Cable construction - PXP4040/C/A, PXP4041/C/C & PXP4043/C

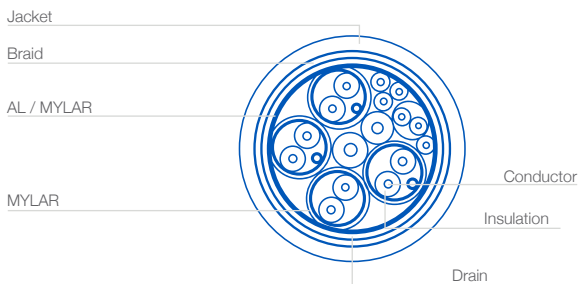

PXP4043/C

	Wire Colour	Label	Type	Cable Number	PCB Header Plugs P2	PCB Header Plugs P3
A1	-	Gnd	Braid	-	1	-
A2	Orange	Tx1+	(Shielded Twisted)	3	2	-
A3	Brown	Tx1-	(Shielded Twisted)	3	3	-
A4	Red	Vbus	Power	11	4	-
A5	Blue	CC	Single	10	5	-
A6	White	D0+	(Shielded Twisted)	5	6	-
A7	Green	D0-	(Shielded Twisted)	5	7	-
A8	Orange	SbuA	Single	8	8	-
A9	Red	Vbus	Power	11	9	-
A10	Blue	Rx2+	(Shielded Twisted)	2	10	-
A11	Black	Rx2-	(Shielded Twisted)	2	11	-
A12	-	Gnd	Braid	-	12	-
B1	-	Gnd	Braid	-	-	12
B2	White	Tx2+	(Shielded Twisted)	1	-	11
B3	Red	Tx2-	(Shielded Twisted)	1	-	10
B4	Red	Vbus	Power	11	-	9
B5	Yellow	Vconn	Single	9	-	8
B6	Purple	DI-	(Twisted Pair)	6	-	7
B7	Grey	DI+	(Twisted Pair)	6	-	6
B8	Brown	SbuB	Single	7	-	5
B9	Red	Vbus	Power	11	-	4
B10	Yellow	RX1-	(Shielded Twisted)	4	-	3
B11	Green	RX1+	(Shielded Twisted)	4	-	2
B12	-	Gnd	Braid	-	-	1

Receptacle Plug Colour Key:

- A1, A12, B12, B1: Cable Ground
- A2, A3, B3, B2: High Speed Path (TX for USB or for DP Alt mode)
- A4, A9, B9, B4: Cable Bus Power
- A6, A7, B7, B6: USB 2.0 Interface
- A8, B8: For Sideband Use (not used for USB)
- A5, B5: Plug Configuration Detection (- One becomes Vconn, for cable or adaptor power. - CC is used for USB-PD communication)
- A10, A11, B11, B10: High Speed Data Path (RX for USB, or TX for DP Alt Mode)

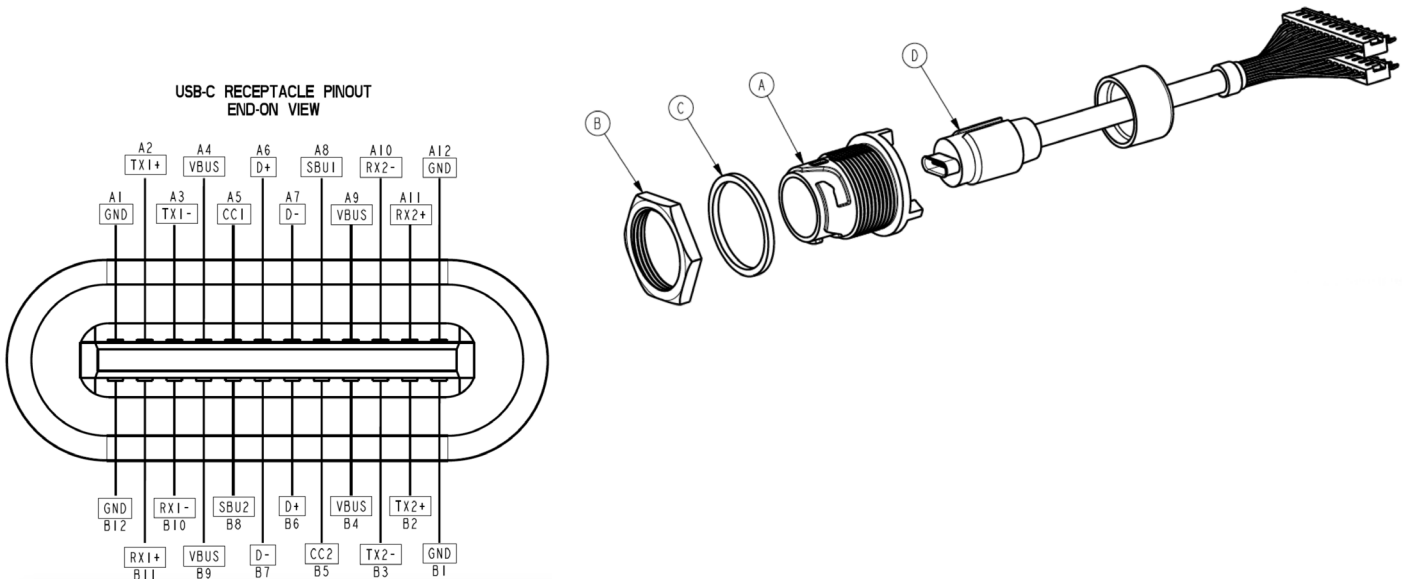

PXP4040/C/A

	Wire Colour	Label	Type	Cable Number	USB-3 Plug P2
A1, B1, A12, B12	-	Gnd	Braid	-	4, 7
A4, B4, A9, B9	Red	Vbus	-	10, 11	1
A5	-	CC	-	-	-
B5	-	Vconn	-	-	-
A6	Green	Dp 1	(Twisted Pair)	5	3
A7	White	D -	(Twisted Pair)	5	2
A2	Blue (Brown Jacket)	SSTXp 1	(Twisted Pair)	1	6
A3	White (Brown Jacket)	SSTXn 1	(Twisted Pair)	1	5
B11	Blue (Red Jacket)	SSRXp 1	(Twisted Pair)	2	9
B10	White (Red Jacket)	SSRXn 1	(Twisted Pair)	2	8
Shell	-	-	Braid	Screen	Shield

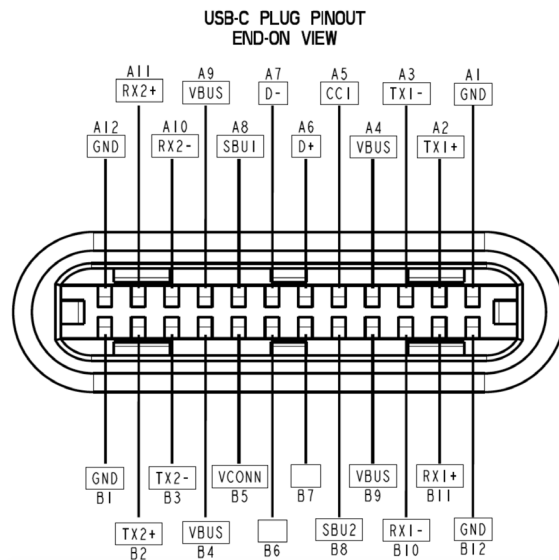

Wiring Notes:

1. Cable used has shielded twisted pairs with drain wires used for all SDP's.
2. Pin A5 (CC) of the USB Type-C Plug shall be connected to Vbus through a 56 K Ω \pm 5% resistor.
3. Contacts B6 and B7 are not connected in the USB Type-C Plug.
4. All Vbus pins are connected together within the USB Type-C Plug. A Bypass Capacitor is required between the ground pins in the USB Type-C Plug side of the cable. The Bypass Capacitor is 10nF \pm 20%. The bypass capacitor shall be as close as possible to the power supply pad.
5. All ground return pins are connected together within the USB Type-C Plug.
6. Shield and Gnd grounds are connected within the USB Type-C and USB 3.1 standard-A plugs on both ends of the cable assembly.
7. All USB Type-C plug pins that are not listed in this table shall be open (not connected).

6000 Series Buccaneer – **circular connectors** that combine the ease of use of a **push/pull coupling mechanism** with proven environmental sealing. Available with **metal** or **plastic** bodies, the range supports both data (USB and Ethernet), signal and mains power. Designed and independently tested to **IP66, IP68 & IP69K** standards, they are ideal for applications where ingress of dust and water must be avoided and where ease of connection, space and appearance are important considerations.

- **30° twist locking**
Tamperproof lock prevents accidental un-mating
- **IP66, IP68 and IP69K when mated**
Suitable for a wide range of dust and water borne environments
- **Independent sealing tests**
IP Ratings independently verified
- **USB version 2.0 performance**
Low and high speed bus connection, 1.5Mbps to 480Mbps
- **Plug and play capability**
Hot pluggable, standard 4 Contact interface
- **Shielded system**
High noise immunity and EMI protection
- **Single and double ended cables**
Suitable for PCB and peripheral configuration
- **Push-pull latching system***
Secure, instant latching. Quick connector mating and release
- **Cat 5e compliant**
Data rate up to 100Mbps
- **PUR jacket on cable**
Good chemical resistance, flame retardant
- **Cat 5e shielded coupler**
Maintains shielding
- **Visual mating indication**
Alignment indicator reduces risk of damage during mating
- **Earth lead version of panel adaptor on plastic connector**
Continuous screening of panel mount connector
- **Metal connector grounded to cable screen**
Continuous screening of panel mount connector
- **Sealed through panel Ethernet**
Prevent water ingress into equipment
- **EN60068-2-52 Test Kb Salt Mist (Cyclic)**
Marine Severity Level 1



Sealed USB Cables - Single Ended



PXP6040/A



PXP6040/B

- Single ended sealed cable assembly
- Mates with all panel mounting connectors
- 30° twist locking
- IP rated 'A' type USB connector to standard 'B' type USB connector, mates with all panel mount connectors
- IP rated 'B' type USB connector to standard 'A' type USB connector, mates with all panel mount connectors
- Available in 2m, 3m & 5m lengths

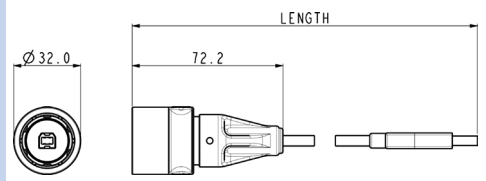
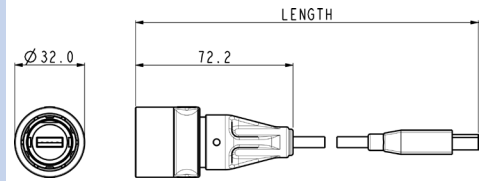

Part no	Length	Description
PXP6040/A/2M00	2m	IP rated A type USB to standard B type USB
PXP6040/A/3M00	3m	IP rated A type USB to standard B type USB
PXP6040/A/5M00	5m	IP rated A type USB to standard B type USB
PXP6040/B/2M00	2m	IP rated B type USB to standard A type USB
PXP6040/B/3M00	3m	IP rated B type USB to standard A type USB
PXP6040/B/5M00	5m	IP rated B type USB to standard A type USB

Sealed USB Cables - Double Ended



PXP6041/AB

- Double ended sealed cable assembly
- Mates with all panel mount connectors
- 30° twist locking
- IP rated 'A' type USB connector to 'B' type USB connector
- Available in 2m, 3m & 5m lengths

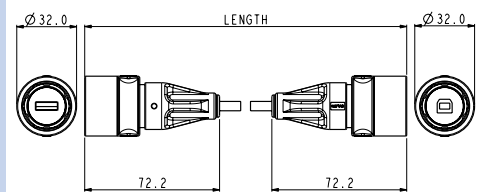

Part no	Length	Description
PXP6041/AB/2M00	2m	IP rated A type USB to IP rated B type USB
PXP6041/AB/3M00	3m	IP rated A type USB to IP rated B type USB
PXP6041/AB/5M00	5m	IP rated A type USB to IP rated B type USB

BUCCANEER FOR DATA
6000 Series - USB Buccaneer

USB Thermo Plastic



Front Panel Mounting Connector



PXP6042/B PXP6042/A

- PXP6042/A - USB 'A' type IP rated connector
- PXP6042/B - USB 'B' type IP rated connector
- Opposite USB type connector to rear of panel
- Mates with PXP6040 and PXP6041 cable connectors

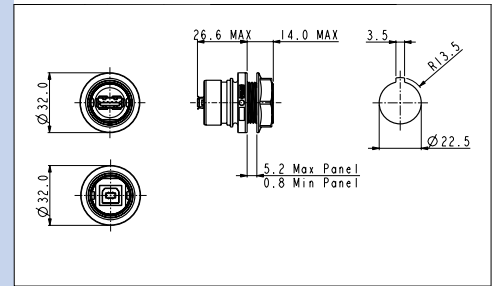

Part No. **Description**

PXP6042/A	IP rated A type USB, front panel mounted. Sealed A type at front of panel, standard B type at rear.
PXP6042/B	IP rated B type USB, front panel mounted. Sealed B type at front of panel, standard A type at rear.

Front Panel Mounting Connector



PXP6043/B PXP6043/A

- PXP6043/A - USB 'A' type IP rated connector
- PXP6043/B - USB 'B' type IP rated connector
- Leaded with 5 way crimp connector
- Mates with PXP6040 and PXP6041 cable connectors

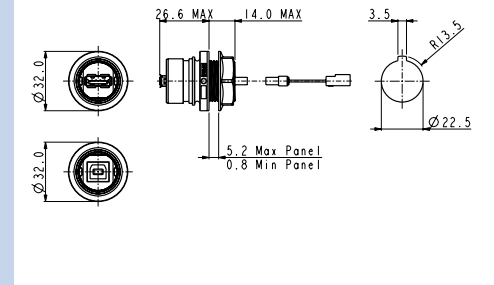

Part No. **Description**

PXP6043/A	IP rated A type USB, front panel mounted. Sealed A type at front of panel, 5 way crimp connector at rear.
PXP6043/B	IP rated B type USB, front panel mounted. Sealed B type at front of panel, 5 way crimp connector at rear.

PCB Adaptor Leads

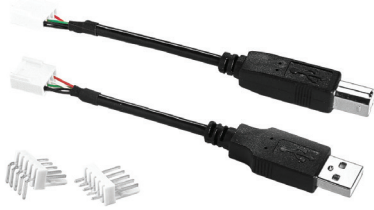

- Standard A and B type USB connectors to 5 way crimp adaptor leads
- 5 way headers, 2.54mm pitch, horizontal or vertical mounting

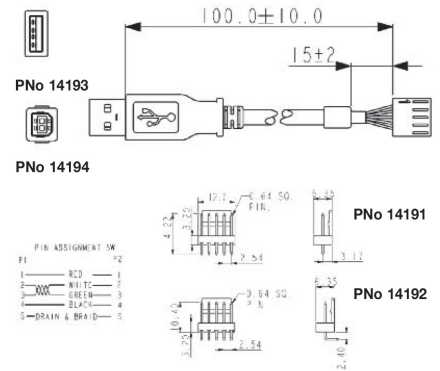

Part No.	Description
14193	USB 'A' type to 5 way crimp connector
14194	USB 'B' type to 5 way crimp connector
14191	5 way PCB header straight
14192	5 way PCB header right angle

Sealing Caps



PXP6083 & PXP6081

- Sealing caps to maintain IP rating when connectors are not in use
- PXP6081 for cable connectors PXP6040 & PXP6041
- PXP6083 for front panel mount connectors PXP6042 & PXP6043, with 30° twist lock

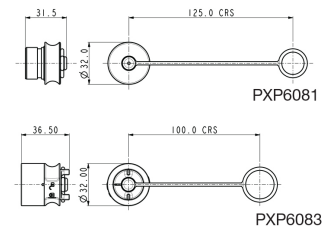

Part No.	Description
PXP6081	Sealing Cap for Flex cable connectors (PXP6040, PXP6041)
PXP6083	Sealing Cap for front panel mounting connector (PXP6042, PXP6043)

BUCCANEER FOR DATA
6000 Series - USB Buccaneer

USB Thermo Plastic - Part No System



PXP	6XXX	X or XX	XXXX
<p>Series Designation</p>	<p>Series / Body Style</p> <p>040 = Single ended cable 041 = Double ended cable 042 = Panel with adaptor 043 = Panel with lead</p>	<p>Characteristics</p> <p>A = 'A' type sealed interface B = 'B' type sealed interface AB = 'A' & 'B' type sealed interface (for use with 6041 only)</p>	<p>Cable length</p> <p>2M00 = 2 metre cable length (for use with 6040 and 6041 cables only) 3M00 = 3 metre cable length (for use with 6040 and 6041 cables only) 5M00 = 5 metre cable length (for use with 6040 and 6041 cables only) Blank for 6042 & 6043 panel bodies</p>

Examples

PXP6040/A/2M00 = Cable assembly with sealed 'A' type connector to unsealed 'B' type connector, 2 metres long

PXP6042/A = Panel mounted adapter with sealed 'A' type to unsealed 'B' type at rear

BUCCANEER FOR DATA
6000 Series - USB Buccaneer

USB Thermo Plastic - Specifications



Cables & connectors

Mechanical

Sealing	IP69K, DIN40050-9 IP68, EN60529:1992+A2:2013 (10m depth for 2 weeks) IP66, EN60529:1992+A2:2013
Salt Mist	EN60068-2-52 Test Kb Salt Mist (Cyclic) Marine Severity Level 1
Operating temperature	0°C to +70°C

Electrical

No. of Contacts	4
Current rating	1A
Voltage rating	30V AC (RMS)
Contact resistance	30mΩ max.
Performance	USB version 2.0

Materials - Overmoulded

Overmould material	PVC (black)
Flammability rating	UL94V-0

Materials - Re-wireable and Panel Connectors

Plastic	PC/PBT
Metal	Machined Brass, Nickel Plated
Flammability rating	UL94V-0
'O' rings	Silicone
Panel Gasket - round	Silicone
Panel Gasket - flange	Silicone

Materials - cable

Cable Jacket	PVC (black)
Screen	Tinned copper braid
Flammability	UL94V-0
RoHS	Compliant

Length:	Dia	Conductors Signal	Conductors Power
2m	4.8mm	2 x 28AWG	2 x 24AWG
3m	5.0mm	2 x 28AWG	2 x 22AWG
5m	5.2mm	2 x 28AWG	2 x 20AWG

PCB adaptor leads

Electrical

No. of conductors	4
Current rating	1A
Voltage rating	30V AC (RMS)
Contact resistance	<10mΩ max.
PCB pitch	2.54mm

Materials

Moulding	Polycarbonate
Flammability	UL94V-0
Contact material	Copper Alloy
Contact plating	30 micro inch Gold
Wire insulation	PVC (black)
Flammability	UL94-V0
Conductors	4 x 28AWG
Operating temperature	0°C to +70°C
Mating cycles	1,000
RoHS	Compliant

Cable construction - PXP6040, PXP6041

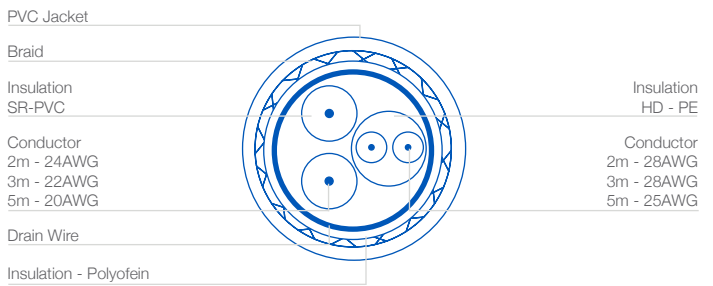

BUCCANEER FOR DATA
6000 Series - Ethernet Buccaneer

Thermo-plastic version



Patch Cord Flex Connector - Pur Jacket Cable



PXP6037

- Mates with PXP6033TP type panel mounting connectors
- 30° twist locking
- Overmoulded patchcords with IP rated connector
- Supplied with shielded RJ45 plug
- Single or double end terminated
- Standard lengths: 2m, 3m & 5m
- S-FTP cable construction
- PUR jacket cable
- Wiring configuration to 568-B
- Exceeds EIA/TIA Cat 5e

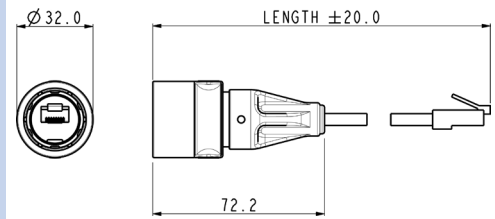

Part no	Type	Length	Description
PXP6037/2M00	Single ended	2m	IP RJ Buccaneer to Shielded RJ45
PXP6037/3M00	Single ended	3m	IP RJ Buccaneer to Shielded RJ45
PXP6037/5M00	Single ended	5m	IP RJ Buccaneer to Shielded RJ45

Patch Cord Flex Connector - Pur Jacket Cable



PXP6038

- Mates with PXP6033TP type panel mounting connectors
- 30° twist locking
- Overmoulded patchcords with IP rated connector
- Supplied with shielded RJ45 plug
- Single or double end terminated
- Standard lengths: 2m, 3m & 5m
- S-FTP cable construction
- PUR jacket cable
- Wiring configuration to 568-B
- Exceeds EIA/TIA Cat 5e

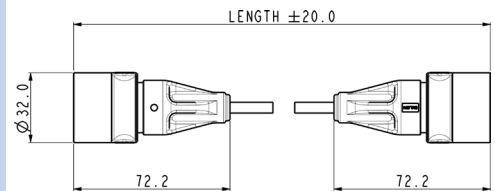

Part no	Type	Length	Description
PXP6038/2M00	Double ended	2m	IP RJ Buccaneer to IP68 RJ Buccaneer
PXP6038/3M00	Double ended	3m	IP RJ Buccaneer to IP68 RJ Buccaneer
PXP6038/5M00	Double ended	5m	IP RJ Buccaneer to IP68 RJ Buccaneer

Rewireable Flex Connector



PXP6034

- Mates with PXP6033TP type panel mounting connectors
- 30° twist locking
- Supplied with shielded RJ45 plug
- Two versions:
for PUR jacket cable (Cat 5e)
for other cable sizes from
4.0 to 10.0mm dia.

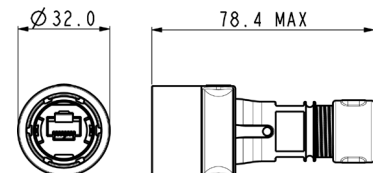

Part no	Description
PXP6034/A	Cable glands optimised for PUR jacket cable to maintain Cat 5e performance
PXP6034/B	Suitable for use with cables from 4.0 to 10.0mm diameter

Front Panel Mounting Connector



PXP6033TP

- Sealed through panel
- Cat 5e shielded coupler
- Mates with all plastic flex connectors
- Standard RJ45 patchcord can be plugged into rear
- Version with earth wire available
- Single hole fixing
- Complete with panel sealing gasket

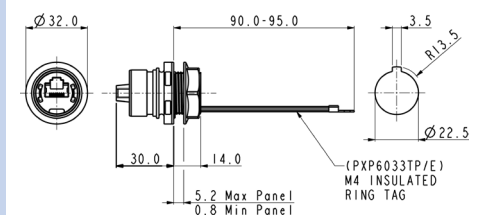

Part no	Description	Fixing
PXP6033TP	Cat 5e coupler	Front panel mounted - sealed through panel
PXP6033TP/E	Cat 5e coupler + earth wire	Front panel mounted - sealed through panel

Re-wireable Flex Connector



PXM6034

- Mates with PXM6033TP type panel mounting connectors
- 30° twist locking
- Supplied with shielded RJ45 plug
- Two versions:
for PUR jacket cable (Cat 5e)
for other cable sizes from
4.0 to 10.0mm dia.

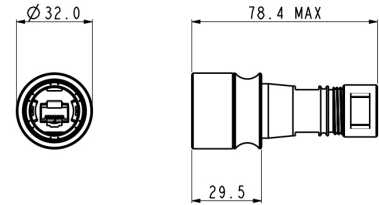

Part no

Description

PXM6034/A	Cable glands optimised for PUR jacket cable to maintain Cat 5e performance
PXM6034/B	Suitable for use with cables from 4.0 to 10.0mm diameter

Front Panel Mounting Connector



PXM6033

- Sealed through panel
- Cat 5e shielded coupler
- Mates with PXM6034 type flex connectors
- Standard RJ45 patchcord can be plugged into rear
- Connector shell ground to cable screen
- Single hole fixing
- Complete with panel sealing gasket

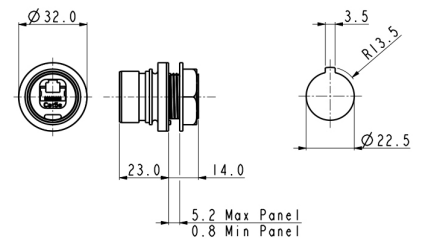

Part no

Description

Fixing

PXM6033TP	Cat 5e coupler	Front panel mounted - sealed through panel
-----------	----------------	--

Sealing Caps



PXP6083 & PXP6081

- Plastic connectors
- PXP6081 for cable connectors
 - PXP6034, PXP6037 & PXP6038
 - PXP6083 for front panel mount connectors PXP6033, with 30° twist lock

Sealing caps to maintain IP rating when connectors are not in use

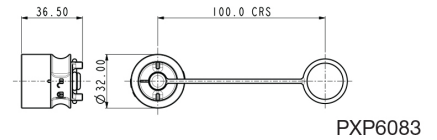
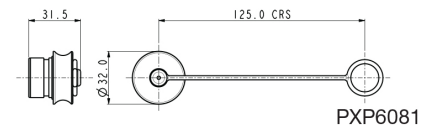

Part no

Description

PXP6081	Sealing Cap for plastic Flex cable connectors
PXP6083	Sealing Cap for plastic front panel mounting connector

Sealing Caps



PXM6083 & PXM6081

- Metal connectors
- PXM6081 for cable connectors
 - PXM6034
 - PXM6083 for front panel mount connectors

Sealing caps to maintain IP rating when connectors are not in use

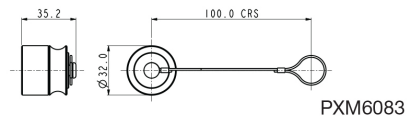
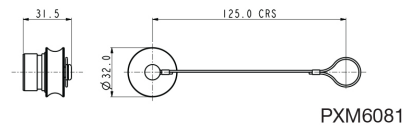

Part no

Description

PXM6081	Sealing Cap for metal Flex cable connectors
PXM6083	Sealing Cap for metal front panel mounting connector

14151	Hand crimp tooling + die set
14199	PUR Jacket cable - 50m reel
14150	Replacement shielded RJ45



Series Designation

PXP - Plastic
 PXM - Metal

Series / Body Style

033 = Panel
 034 = Re-wireable Flex
 037 = Patchcord
 (Single Ended)
 038 = Patchcord
 (Double Ended)

Panel Sealing

TP = through panel sealing (for use
 with PXP6033 panel body only)

 Blank = not applicable

Characteristics

E = Earth lead (for use with PXP6033 plastic panel body only)
 A = Glanding for PUR cable (for use with PXP6034 re-wireable flex only)
 B = Glanding for 3.5 to 8mm cables (for use with PXP6034 re-wireable flex only)
 2M00 = 2 metre cable length (for use with PXP6037 and PXP6038 patchcords only)
 3M00 = 3 metre cable length (for use with PXP6037 and PXP6038 patchcords only)
 5M00 = 5 metre cable length (for use with PXP6037 and PXP6038 patchcords only)

Examples

PXP6033TP/E= Panel mounted coupler, sealed through panel with earth lead

PXP6037/2M00= Patchcord with one sealed end, 2 metres long

PXM6034/A = Flex re-wireable connector for use with PUR cable

PXM6033TP = Panel mounted coupler, through panel sealed

Ethernet – Metal and Thermo-plastic versions

Connectors

Mechanical

Sealing	IP69K, DIN40050-9 IP68, EN60529:1992+A2:2013 (10m depth for 2 weeks) IP66, EN60529:1992+A2:2013
---------	--

Salt Mist:	EN60068-2-52 Test Kb Salt Mist (Cyclic) Marine Severity Level 1
------------	--

Operating Temperature	
Re-wireable and Metal	-20°C to +70°C
Overmoulded patchcords	0°C to +70°C

Materials - Overmoulded

Overmould material	PVC (black)
Flammability rating	UL94V-0

Materials - Re-wireable and Panel Connectors

Plastic	PC/PBT
Metal	Machined Brass, Nickel Plated
Flammability rating	UL94V-0
'O' rings	Silicone
Panel Gasket - round	Silicone
Panel Gasket - flange	Silicone
Approvals	

RoHS	Compliant
------	-----------

Stranded S-FTP Patch cord cable - PUR Jacket

Polyurethane (PUR) jacket cable with internal construction exceeding Cat 5e performance levels. The PUR jacket has excellent abrasion, chemical and ozone resistance, low smoke, low halogen flame retardant construction suitable for internal and external industrial environments.

Cable

Conductors	24AWG (7/0.2mm) bare copper
Insulation	HD-PE
Pair	2 of the above cores twisted
Core	4 of the above cores
Tape	1 lap mylar tape
Screen	1 layer mylar and aluminium tape, 0.12mm tinned copper braid
Sheath	PUR Jacket Black
Op Temperature	-25°C to +85°C
Min. bend radius	10 x O/D (installation)
Min. bend radius	6 x O/D (installed)
Diameter	6.1mm nominal

Electrical @ 20°C

Characteristic Impedance	100Ω ±15Ω @ 100MHz
Capacitance	330pF/km
Conductor Loop resistance	29Ω/100m maximum
Skew	45 nsec/100m @ 100MHz
TIA/EIA Rating	Cat 5e & POE

Cable construction - PXP6037, PXP6038 and 14199

PCB adaptor leads

Electrical

No. of conductors	4
Current rating	350mA
Voltage rating	37V - 57V
Contact resistance	<10mΩ max.
PCB pitch	2.54mm

Materials

Moulding	Polycarbonate
Flammability	UL94V-0
Contact material	Copper Alloy
Contact plating	30 micro inch Gold
Wire insulation	PVC (black)
Flammability	UL94-V0
Conductors	4 x 28AWG
Operating temperature	0°C to +70°C
Mating cycles	1,000
RoHS	Compliant

Cable construction - PXP6040, PXP6041

24 AWG - 7/0.20mm conductor		Mylar tape
Braiding 7/0.12mm		Insulation - HD-PE
Jacket 6.10mm dia.		Aluminium/PEPT tape
		Drain Wire